

# Wireless Weekly

Vol. 7. No. 4.

IN THIS ISSUE:-



EXCLUSIVE ACCOUNT  
of the RICE AMAZON  
EXPEDITION

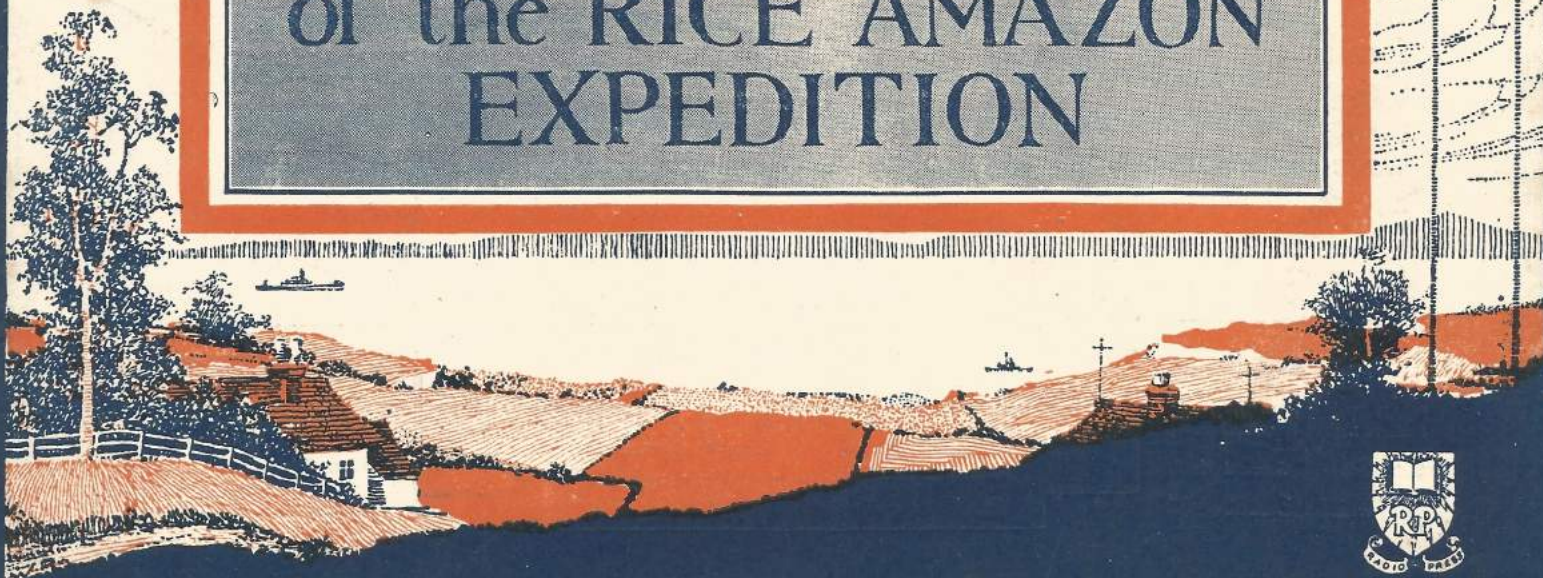





## The new Burndept Coils

- cover all waves from 20 metres upwards
- are enclosed in special sealed containers
- fit all makes of tuners and coil holders

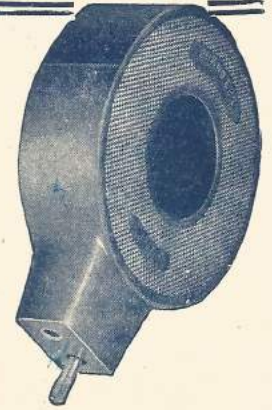

**I**N the latest pattern Burndept Coils, several important changes have been made. Each Coil is enclosed in an hermetically sealed moulded container, on the outside of which the tuning range and number is indicated. The new Coils, which fit all standard makes of tuners and coil holders, are numbered to correspond with somewhat similar coils of other makes, and are all the same size externally:  $4\frac{1}{4}$  in. long,  $3\frac{5}{8}$  in. wide, and  $1\frac{1}{10}$  in. thick. As the Coils are perfectly protected from damp and dust, they will maintain their original high efficiency indefinitely. The complete set covers all waves from 20 to 22,000 metres.

Coils 3 to 20 are intended for ultra short waves—20 to 150 metres. They are wound with heavy gauge bare copper wire on Grade A ebonite formers; so-called "low-loss air-spaced" coils are *not* essential for successful short wave reception. Coils 3, 5, 10, 15 and 20, 5s. each.

Coils 25 to 75 are the famous Burndept Concert Coils, covering all waves from 150 to 800 metres. These coils which give

unequalled signal strength and extraordinary clarity, each consist of a single-layer winding on Admiralty Paxolin formers. Coils 25, 35, 40, 50 and 60, 4s. 3d. each. Coil 75, 4s. 6d.

Coils 100 to 1,500 are the celebrated Burndept patent multi-layer coils, covering all waves from about 700 to

22,000 metres. Coil 100, 5s.; Coil 150, 6s.; Coil 200, 7s.; Coil 300, 8s.; Coil 400, 9s.; Coil 600, 10s.; Coil 1,000, 15s.; Coil 1,500, 17s. 6d.

These Coils may also be purchased in sets, as follows:

No. 955.—For Broadcast Reception (200 to 800 metres). Set of four Concert Coils, 35, 50, 60 and 75, 16s.

No. 956.—For Long-Wave Reception (700 to 22,000 metres). Set of eight Coils, 100 to 1,500, £3 17s. 6d.

No. 957.—Complete set of nineteen Coils, covering all waves from 20 to 22,000 metres, £6.



The 1924-25 pattern Burndept Coils have been considerably reduced in price. Full particulars of these reductions will be sent free on request.

Full particulars of these new Coils are given in Burndept Publication No. 44, a copy of which will be sent to any reader of this journal on application. The Burndept Range includes everything for radio reception from components to complete installations. Build your set with Burndept Components and be sure of best results.

HEAD OFFICE: Aldine House,  
Bedford Street, Strand, London,  
W.C.2.

Telephone: Gerrard 9072.

Telegrams: Burndept,  
Westrand, London.

# BURNDEPT

## WIRELESS LIMITED

BRANCHES: Belfast, Birmingham, Brighton, Bristol, Cardiff, Exeter, Glasgow, Leeds, Liverpool, Manchester, Newcastle, Northampton and Nottingham.



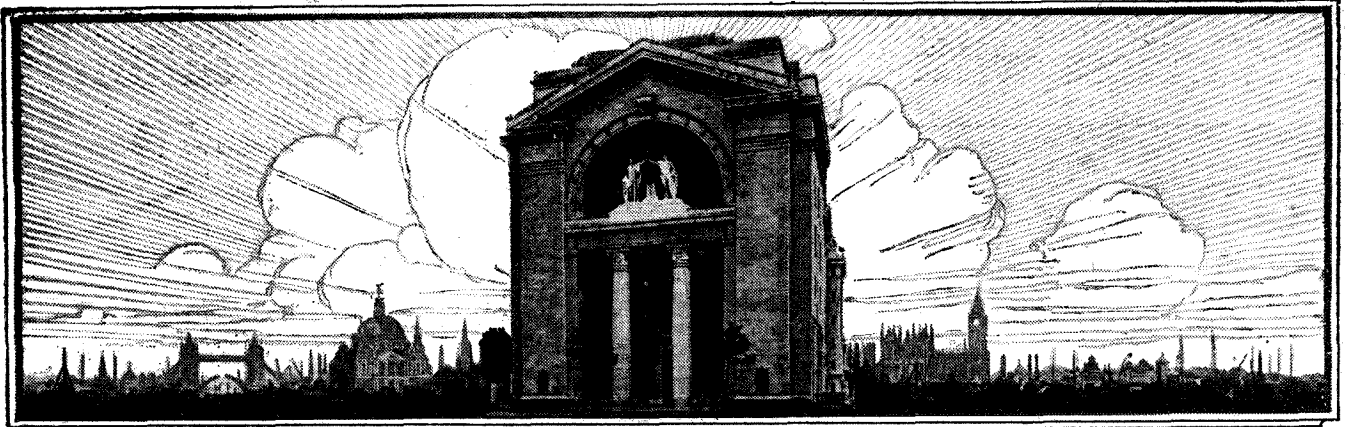

**Radio Press** LTD

**Wireless Weekly**  
Phone City, 9911

**Bush House** STRAND-WC2

## The Oscillation Peril

WITH the passing of Summer Time and the lengthening of the evenings, telephone receivers will be donned far more regularly and for longer periods than has been the case during the past summer. It does not require much prophetic vision to see that the coming winter will be the greatest radio winter we have yet experienced, and whether or not the full enjoyment of it is the state promised will depend largely upon the amount of radiation that takes place from regenerative receiving circuits. Most readers of *Wireless Weekly* are, of course, well able to handle their receivers in such a way as not to cause interference to others, and while there are some skilled offenders, we believe that practically all the trouble arises from mishandling of sets by those who are quite innocent of any intention to give trouble to their neighbours.

What is the main howling trouble? Does it not arise from the adjustment of sets in such a way that oscillation is taking place and the circuit is just de-

tuned from the carrier wave so as to give a "wail"? If the "wail" heard passes backwards

adjustment, many people—even experienced wireless men, picture a listener frantically swinging his dial backwards and forwards in a vain hunt for the station he cannot hear. It is not generally realised that these wailing howls generally arise from very slight movements of the dial.

Between the wavelengths of 370 and 380 metres there is a difference of roughly 20 kilocycles, from which it follows that variations in tuning of an oscillating receiver by even a metre would take the beat note from inaudibility to a high piercing whistle.

Readers of *Wireless Weekly* can do much good by short chats with their less experienced friends, pointing out to them that the slightest movement of the dial, when the receiver is oscillating, will cause the trouble to which we have referred; that, even if they are lucky enough to maintain the set on the zero beat, reception in this way is always distorted; and finally that British sportsmanship is required, if wireless is to become a universal hobby.

### CONTENTS.

|  | Page |
|--|------|
| Wireless in the Rice Amazon Expedition ..                                    | 106  |
| Practical Short-wave Reception ..  | 109  |
| Jottings By The Way ..   | 112  |
| Some Notes on Tuning and Selectivity ..                                      | 114  |
| New British Valves ..  | 117  |
| Appointment of Mr. H. J. Barton-Chapple to the Staff of Radio Press, Ltd. .. | 120  |
| A Loud Speaker Circuit for the Local Station ..                              | 121  |
| The Wireless Exhibition at the Horticultural Hall ..                         | 124  |
| Wireless News in Brief ..  | 128  |
| Straight-Line Frequency Dials ..   | 129  |
| Apparatus We have Tested ..  | 133  |
| Correspondence ..  | 134  |
| Information Department ..  | 137  |

and forwards through the zero point very slowly, it is an indication that the listener is trying to settle down on the zero point of the beat note. On hearing the howl arising from this mal-

Director of Research :  
Major JAMES ROBINSON, D.Sc., Ph.D., F.Inst.P.  
Deputy Director of Research :  
Capt. H. L. CROWTHER, M.Sc.  
Assistant Editor :  
PERCY W. HARRIS, M.I.R.E.  
Scientific Adviser :  
Prof. G. W. O. HOWE, D.Sc., M.I.E.E.  
Advisory Editors :  
Prof. R. WHIDDINGTON, M.A., D.Sc., F.R.S.  
Prof. C. L. FORTESCUE M.A., M.I.E.E.

Edited by  
**JOHN SCOTT-TAGGART,**  
F. Inst. P., A.M.I.E.E.

October 14, Vol. 7, No. 4.

Nothing contained herein is to be regarded as permission or encouragement to infringe any patent rights.

Staff Editors :  
E. H. CHAPMAN, M.A., D.Sc.  
A. D. COWPER, M.Sc.  
R. W. HALLOWS, M.A.  
G. P. KENDALL, B.Sc.  
A. JOHNSON-RANDALL  
STANLEY G. RATTEE, M.I.R.E.  
J. H. REYNER, B.Sc. (Hons.),  
A.C.G.I., D.I.C.

# Wireless with the Rice Amazon Expedition

By T. E. McCaleb.

*The author of this article is the wireless operator who kept the Rice Expedition in touch with civilisation from the hitherto unexplored districts of the River Amazon. He gives here some of his personal experiences.*



*A general view of Manaus, distant over 1,000 miles from the mouth of the River Amazon, which was intended to be a link in the wireless communications between the expedition and New York.*

ONE of the outstanding features of the Hamilton Rice expedition to South America in 1924-25 was the successful radio communication carried on between the two radio stations of the expedition with the various points in the civilised world.

Regardless of practical experience and knowledge of combating the elements of the wilds, an expedition cannot plan every preparation for supplies to maintain them for an estimated period of time to reach a goal the position of which is merely calculated, and the intervening territory unknown.

### Advantages of Wireless

Many causes that delay progress occur, and wireless can be used to send a request for additional food supplies and medicines. With wireless the party can keep its base or headquarters informed of immediate discoveries, of its progress and of its necessities.

Often while the party may be only 100 miles from civilisation, communication by post to keep those interested in the welfare of the members of the party informed may require many months. This news, welcome as it is, is not satisfactory, because of the time which has elapsed. But with wireless, word may be sent and received in a few minutes.

The Rice Expedition was kept in touch with the world by the A.R.R.L., the original scheme of communication on long waves with

the Brazilian station at Manaus having failed because of adverse atmospheric conditions.

### Failure of Long Waves

After interruption on the long waves occurred the writer got into communication with 2CVS in New York City, who volunteered to maintain a schedule each night so that communication could be resumed with the outside world. This method was a tremendous time-saver when compared to the earlier process of radio communication from the base station to Manaus, and thence to New York via cable.

Later, a consistent schedule was maintained with Station 2MC at New York, who very efficiently kept a mighty volume of two-way traffic moving.

### Other Stations

A number of other American amateurs rendered a great service by accepting messages from persons in the States for the expedition and receiving expedition messages for the United States, not to speak of many times when they stood by for other traffic.

The greatest distance covered was that in exchanging signals and conversation with New Zealand station 2AP, located at Wellington, at a distance of approximately 8,500 miles from our party.

Mr. Gerald Marcuse, of Station 2NM, at Caterham, near London, was the chief English station to connect with the expedition. His

station handled several long messages from Dr. Rice to the Royal Geographical Society.

Station 2AG, owned by Mr. S. R. Runyon and located at Yonkers, N.Y., established a record by receiving a message from an individual in New York and telephoning the reply back, which had been received from the expedition, in approximately eight minutes from the time the message was filed.

### The Aeroplane

During a period in the dry season when the water was rapidly falling, the advance party had penetrated a considerable distance. The aeroplane, with its pilot and photographer, were awaiting word when a flight could be made to meet the party and for vital information concerning landing conditions. Without these reports the plane would have been flown to a spot where the party was encamped, and, in landing, might have run into rocks below the surface of the water, which would have resulted in a serious mishap. The plane being used was of the scout type, with the engine supported above the head of the pilot on a single strut. Any con-



*Dense forest comes down to the water's edge on the Amazon banks.*

siderable jar would cause the engine to come falling on to the pilot's head, which might be classified at least as unpleasant; as it was, the radio link between the advance

party and the base kept the pilot well informed of the conditions he would have to meet.

#### The Base Station

The equipment at the base radio station located at Boa Vista on the Rio Branco consisted of a transmitter using eight 50-watt tubes to generate a power of 400 watts for communication with Manaus, 400 miles south, at a frequency of approximately 100 kc. (3,000 metres).

There are several interesting points in connection with the short-wave receiver and transmitter which will be interesting to the reader who has never found it necessary, in his radio experience, to deal with the diabolical tropical static.

#### Transmitting Apparatus

The transmitter, instead of following the usual plan, is built upon the tuned plate idea. The inductances—and most of the set, for that matter—were constructed out of parts of the long-wave set and spares carried to the base section. Long before the time set for the return of the party the large valves, 50-watters, began to show signs of disintegration. Not wishing to leave things entirely at the hands of chance, small 5-watt valves were arranged in series to furnish the necessary power. By soldering them to a circular ring very good results were obtained. This par-

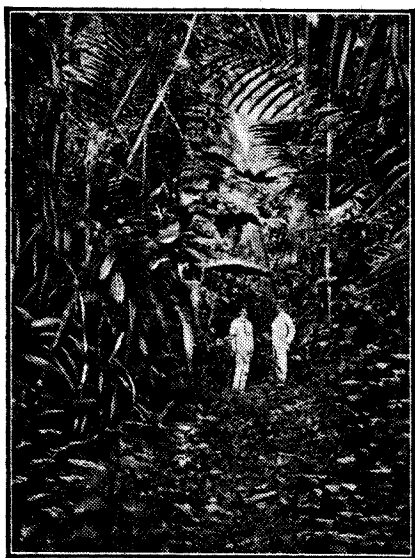

*The difficulties of wireless in country of this sort can be readily appreciated.*

ticular method of mounting kept the effective inductance in each of the valves the same, so that the maximum output was registered in the aerial ammeter.

#### Short-wave Receiver

The receiver is novel. The static conditions were such that the standard circuit sorely tried the operators owing to atmospheric; so, instead of coupling the aerial and earth directly to the tuning inductance of the high-frequency valve, as is ordinarily done—the

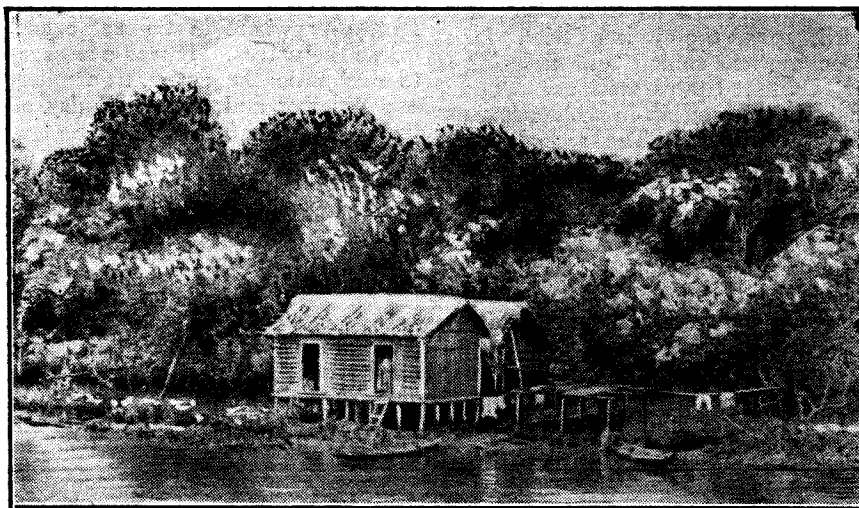

*A typical view on the lower and more open reaches of the Amazon.*

complete set consists of one H.F. detector and one L.F.—the aerial was connected directly to the plate of the detector and then coupled to the high-frequency valve.

A further decrease in static is obtained by using a very low aerial, possibly only 10 or 20 feet above ground, and very short. Both these decrease the signal strength, but at the same time they decrease the static more, resulting in a net advantage.

#### Power Supply

The original engine, which was to have been the primary source of power, was a small air-cooled motor-bicycle engine that flew to pieces due to the centrifugal force. An outboard canoe motor was belted to a small generator which furnished power for charging the 12-volt, 80-ampere-hour storage battery. This supplied the dynamotor for the transmitter, which had an approximate power output of 25 watts. The aeroplane mechanic acted as "engineer" when it became necessary to float the generator and battery together for increased power. Upon signal from the operator the engine was shut down for reception. This method was not necessary at all times, since the battery had sufficient charge for 1½ hours' communication.

#### Tropical Difficulties

At the next semi-permanent camp the portable station was again erected in the midst of the thickest jungle. But at this camp, which was a little further north and west, there were hills more than 1,000 feet high that entirely surrounded the camp. During terrific tropical

storms no difficulty was experienced in communicating with a number of New England and Eastern Seaboard stations, as well as one Canadian.

#### Fading

Contrary to results showing a great decrease in received signal strength during daylight, the signal from LR at 10 a.m. on several occasions proved to be approximately equal in strength to the night signals. Power conditions were the same in both cases. The distance is about 200 miles. The writer had an excellent opportunity to work stations during partial daylight and darkness on January 18 this year. 9ZT at Minneapolis, Minn., was worked during absolute darkness at Boa Vista. Gradually dawn appeared and then bright daylight about 6.40 a.m. 6th meridian time. The two stations, WJS and 9ZT, signed off. The only perceptible difference was an uncanny clarity in 9ZT's signal just at the crack of dawn. Over the remainder of the change in darkness to light no change could be noted.

An instance of wave-jumping occurred when Station LR, after calling United States stations and hearing no answer, decided to quit on account of unfavourable weather conditions. But he heard, just as he was closing down, from a

Canadian station. Later, in a letter from this station, the operator said: "I was surprised to hear you have been unable to work stations in the States for the last week." It is quite obvious that our waves were skipping several thousand miles. The following night reception was again normal.

**Communication with U.S.A.**

On the return to Boa Vista, in April, 1925, the writer tried for three nights, calling and listening for United States stations. The final night a station in Philadelphia took all traffic. The records on which the stations were logged have been mislaid.

At the final semi-permanent camp, where the expedition changed from native canoes to smaller dug-outs belonging to the Indians, the wireless equipment was left behind with other material.

When the party had returned to the other side of the five-mile portage the writer and the aeroplane

high up in the Parima Mountains that form the northern boundary of Brazil, forming the borderline between that country and Venezuela.

**Unusual Troubles**

When the trunk in which the entire portable station had been packed was opened, it was found to contain multitudes of ants and their eggs. They had made homes between the condenser plates—in fact, everywhere in the set except inside the valves. It was necessary to dismantle the entire transmitter and receiver and clean and dry all parts.

But, thanks to the station in Philadelphia, about six messages reached their destination, making known to the world that we were safely on the return voyage after the most difficult portion of the trip.

**Time Signals**

Besides communications, wireless played another important rôle in determining chronometer rates from the received time signals sent out

NBA was found to be unreliable for extreme accuracy, and so it became necessary to change and pick up the signals from NSS.

**Long-wave Receiver**

The long-wave receiver consisted of three valves connected in the usual manner, and had a loop for its collector. Although rather out of the ordinary in constructional details, this receiver worked at all times, despite the drizzling rain and soggy ground on which it often rested. At times it would require a drying by the camp fire to drive the moisture out of the headphones and loop.

**Reception Under Difficulties**

The most interesting experience in obtaining the time check was brought about by the necessity of receiving the noon time signals while under way in a small canoe bound down stream at a seven-mile per hour rate, dodging some rocks and hitting others. It was decided not to waste any time in going ashore, so the apparatus was set up, and the operator cautiously stood in the canoe, supporting and rotating the loop of the set to maintain maximum signal strength. This was highly essential, as the canoe followed all sorts of crooks and turns in the river. Perfect checks were obtained, and no time lost on our downward journey.

**Phenomena Noted**

However, it can be stated that one important discovery was of the association of the presence of high winds with an increase in atmospheric disturbances. This, no doubt, directly follows the theory of dust moving at a high velocity, giving rise to the atmospheric charges which affect radio receivers.

It can also be said that local meteorological conditions have no perceptible influence on the reception of wavelengths below 100 metres. Radio communication from South America to North America on short waves in the vicinity of 80 metres will not be as reliable during the summer months of North America. This fact cannot be attributed to any definite reason. A curious phenomenon observed was the complete trapping of short-wave signals for several days at a time, while again later they would come through with strength.

[We are indebted to the Booth Steamship Co., Ltd., organisers of the Amazon Cruises, for permission to publish the photographs illustrating this article.]

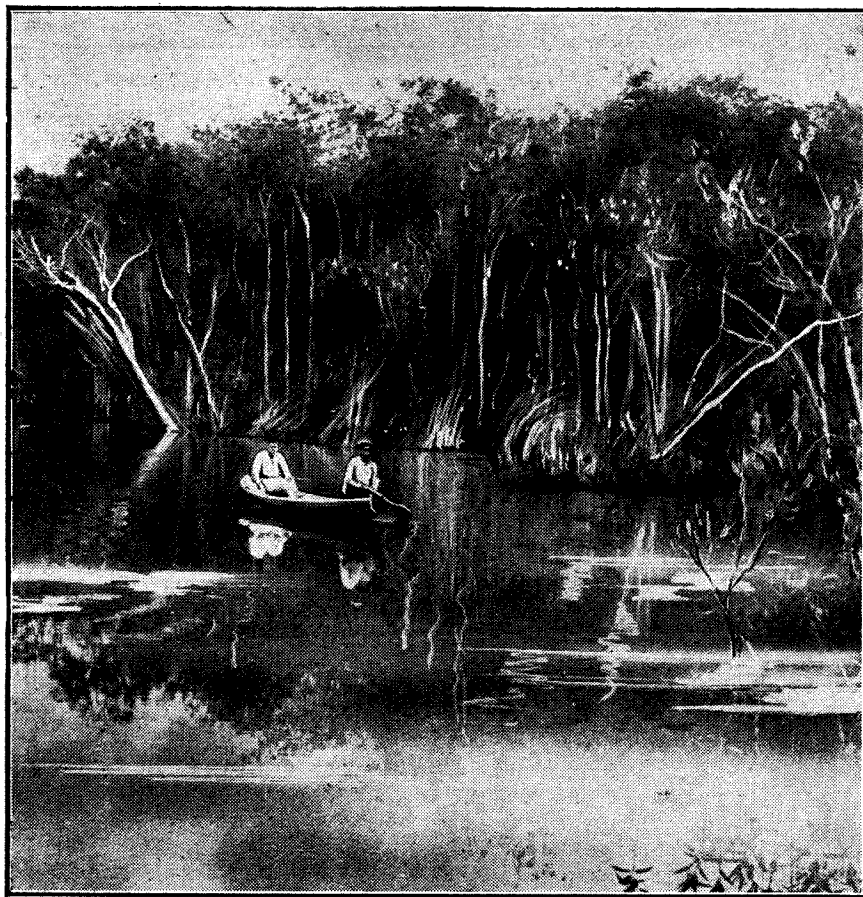

*It was sometimes necessary to receive the noon time signals while actually under way on the river in a canoe.*

mechanic journeyed over to prepare another canoe and send our numerous messages telling of the expedition's success in reaching its goal

from various government stations. Usually the Press and time check from Balboa, Panama (NBA), was received. The time check from

# Practical Short-Wave Reception

## I.—THE CHOICE OF A CIRCUIT.

By G. P. KENDALL, B.Sc., Staff Editor.

*The reception of the shorter waves is becoming a matter of greater and greater interest, and no doubt many readers will be turning their attention to this subject during the coming autumn and winter. For the particular assistance of readers in this position, a special series of articles is being written by Mr. Kendall, which are intended to form an introduction to the subject in its practical aspects.*

UPON first taking up the subject of short-wave reception, by which I mean the reception of signals upon frequencies of 1500 kc. and above (200 metres and below), one is at first apt to think that all that is required is a receiver suitably modified as to its wavelength range, and that the experience gained on the broadcast band will suffice in the new field.

### Difficulties at High Frequencies

As a matter of fact, however, the experimenter who starts off on this assumption is likely to receive quite a number of surprises, possibly starting with the initial one of discovering that although he has made the necessary alterations to his circuit and turn numbers and so on, the set will not oscillate, whatever steps he takes. And following on this, when, by the assistance perhaps of some more experienced friend, he has overcome his first trouble, he may find that although the set will oscillate, and give all the signs of functioning correctly, he simply cannot find any stations, in the end discovering that the reason is that he has quite large variable condensers incorporated in the set, and without any sort of vernier, so that he simply misses every signal, because it is not possible to turn the dials sufficiently slowly.

### Choosing a Circuit

The difficulties of the higher frequencies, then, are very real, and much time can be wasted and disappointment experienced for lack of a little guidance from someone who has already experienced and overcome the difficulties in question. The first thing that must be done upon deciding to take up short-wave reception is obviously to decide upon the circuit which

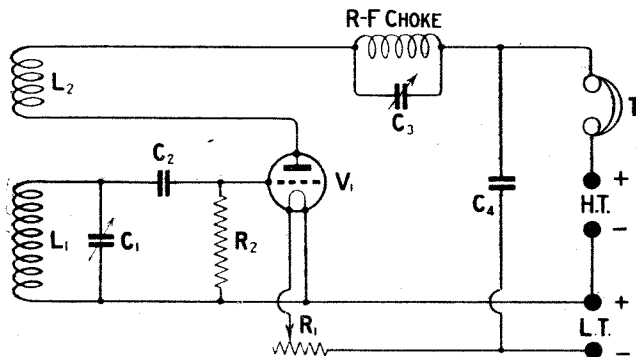

Fig. 1.—One method of producing reaction effects recommended, in which L2 is in a position of fixed coupling relative to L1, and oscillation of V1 is controlled by means of the series by-pass condenser C3.

is to be used, and a discussion of the principal factors involved in making this choice will bring to light a number of the more important points in connection with short-wave reception.

### High-frequency Amplification

The first point that must be realised is that the ordinary methods of high-frequency amplification are practically useless upon the really high frequencies, and hence it follows that for fairly simple and straight-

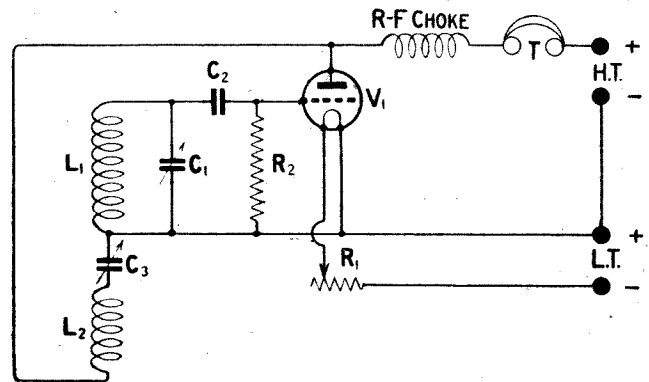

Fig. 2.—A modified form of the Reinartz method of controlling oscillation is shown here, C3 being the reaction condenser.

forward sets high-frequency amplification effects must be obtained by reaction alone. The first valve of the short-wave receiver will therefore be the rectifier, and this, with the aid of a good method of controlling reaction, will produce results upon the higher frequencies, which will seem very wonderful to those who are accustomed to the limited carrying power of the frequencies associated with broadcasting.

### Low-frequency Amplification

To ensure good signal strength in the headphones from practically every station picked up, it is advisable to add a second valve as a note magnifier, and I therefore advise that the reader's first set should consist of two valves, a detector and a note magnifier. This combination, providing that the receiver is designed in accordance with certain rules which will be laid down presently, will be found to give adequate results for all general purposes. If the reader desires to work a loud-speaker from one of the telephony stations, such as KDKA, a second note magnifier valve should, of course, be added, and some scheme of switching provided to bring it into use for this special purpose. It is not desirable to use the three valves for headphone work in general.

### Control of Reaction

Since we are to depend upon reaction for the amplification of the signals prior to rectification, it is obvious that it is well worth while to devote considerable attention to the details of the reaction producing and controlling methods available. It may be laid down as a general rule that the scheme of a swinging reaction coil, which serves the purpose fairly well upon the



lower frequencies, is not suitable for the high ones which we are now considering; the changing of tuning produced by the movement of the coil becomes relatively large, and it is difficult to obtain any delicacy of control.

**Magnetic Reaction**

A method of employing ordinary magnetic reaction and yet of overcoming to a very large extent these difficulties, is that adopted in the Grebe short-wave set, and this is illustrated in its essential features in Fig. 1.

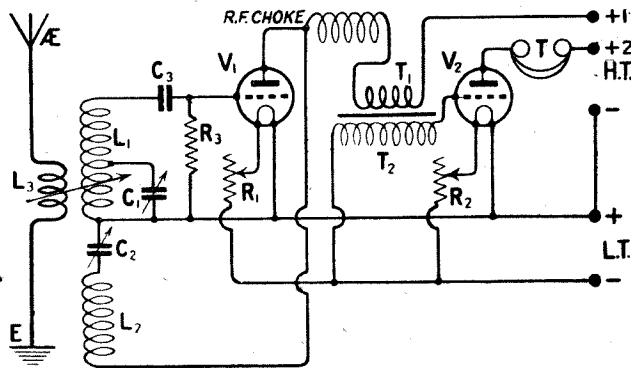

Fig. 3.—A circuit of this type employing a detector and one stage of L.F. amplification, which will be dealt with in detail in subsequent articles in this series.

As will be seen, there is a reaction coil which is placed in a fixed relationship to the grid coil, and the necessary control of reaction is obtained by placing in series with this coil a large radio-frequency choke, shunted by a variable condenser, which serves as a by-pass. Increasing the capacity of this condenser will, therefore, increase the reaction effect, and a very smooth and convenient control is obtained in this way, which has very little effect indeed on the tuning of the grid circuit. This plan may be thoroughly recommended, although it must be understood that a little experimenting with the turn numbers of the reaction coil will probably be necessary to secure satisfactory results.

**Interchangeable Coils**

Both the reaction winding and the grid winding can be arranged upon the same former, and a little ingenuity will produce some scheme for complete interchangeable units, since it is necessary as a rule to change the size of the reaction coil when the grid coil is exchanged for one of a different tuning range. Under these conditions this scheme is thoroughly practical and gives very good results.

**Tuning Range**

One of the great difficulties of short-wave reception is the extremely wide tuning-range required, so that quite a number of interchangeable inductance units are generally needed, and for this reason a scheme of reaction production which would otherwise be extremely attractive, namely, that in which a variometer is used in the anode circuit of the valve, is practically ruled out. Where only a limited range of frequencies is required to be covered, such as in a set which is designed for one specific purpose, such as the reception of KDKA, a suitable variometer is an extremely attractive scheme, but for general work it is very difficult to cover a sufficiently wide range of tuning.

**Reinartz Type of Reaction**

The only other reaction method which I have found really effective is some form of the Reinartz method, and probably the majority of short-wave sets use this

system. A good method of arranging Reinartz reaction in the type of set which we are considering is that illustrated in Fig. 2, and it will be seen that this is practically the standard Reinartz circuit, the aerial arrangements being omitted. I believe that the majority of readers will not require a detailed explanation of the working of the Reinartz reaction scheme, since this has been given many times, but a little information as to turn numbers, etc., may be useful.

**Coil Sizes**

Here again complete interchangeable tuning coil and reaction coil units are desirable, and the relative sizes of the two for most purposes with the type of valve most employed for short-wave reception is that the reaction winding L1 shall be something like two-thirds of the size of the grid winding L2. It is wise, however, to provide some means of varying the number of turns upon L1 in use at any given time, since a number of factors may produce quite wide variations in the number of turns required to produce reaction.

**Aerial Systems**

It will have been noticed that in neither of the circuits so far given is any aerial or earth arrangement shown, and a few words upon this part of the arrangement are desirable. It must be realised that the greater part of our reception will be upon wavelengths below the natural wavelength of the aerial, and it is therefore as a rule not desirable to attempt actually to tune the aerial circuit. One of the so-called aperiodic schemes is probably the best, with a separate winding variably coupled to the grid winding of the receiver.

What is required, in most cases, is a small coil of from 1 to 6 turns, according to the frequency being received, inserted in series between aerial and earth, and variably coupled to the grid coil, and this addition is shown in Fig. 3.

**Hand-capacity Effects**

Another feature which will be noted in Fig. 3 calls for a word of explanation, and that is the fact that the

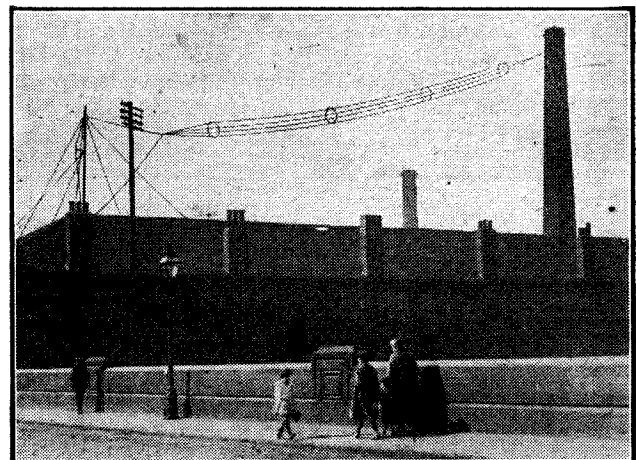

The cage aerial of the Sheffield Broadcasting Station is supported by a factory chimney and a single mast.

variable condenser for tuning the grid circuit is connected across only part of the grid winding. This is quite a useful scheme in practice, the effect being to reduce considerably the hand-capacity effects upon the tuning condenser and also to apply a higher voltage across the grid and filament of the valve than would



have been available if the condenser were connected across the whole coil.

### An Alternative

The latter effect could no doubt have been obtained by the use of a very small variable condenser across the whole coil, since the effect is then very similar, but the desired reduction in hand capacity does not follow. The scheme illustrated, of course, limits the tuning

of the ordinary reaction circuit are absent in the case of the super-heterodyne. The short-wave super-heterodyne is decidedly more difficult to get into proper working order than one for the broadcast frequencies, and I would strongly urge that no reader who has not obtained considerable experience with this instrument upon broadcasting should attempt to use it for short-wave work. Those who possess the necessary qualifications, however, should, with a little patience, be able

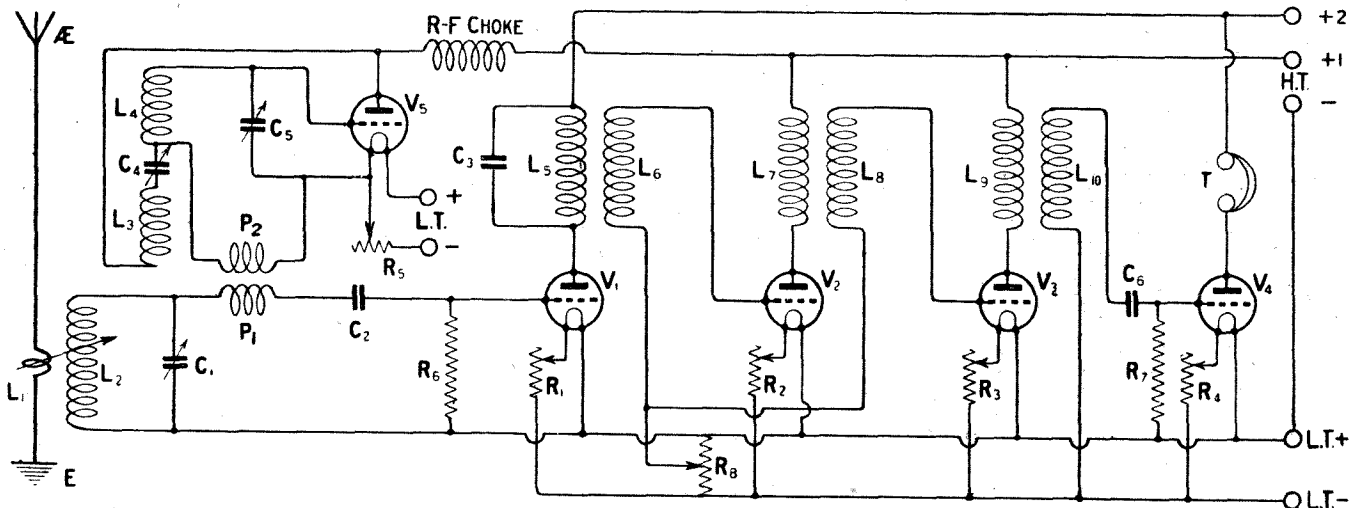

Fig. 4.—The complete circuit diagram of a super-heterodyne receiver, using a separate oscillator valve, V5, coupled by means of two small pick-up coils, P1 and P2, to the grid circuit of V1.

range obtainable with any given coil, just as would the alternative method of using a very small variable condenser across the whole coil to serve the same end of automatically maintaining a large value of inductance in the circuit. When this method is employed, it is therefore necessary to provide a rather larger number of interchangeable coil units.

### Construction of Receiver

It will be seen that I have shown in this figure the addition of the necessary second valve as a note magnifier, with a separate high-tension terminal for its anode supply. I will consider this circuit again next week, and deal with the practical points involved in the construction of the set, such as the turn numbers of the coils and the values of various other components.

### Super-regenerative Circuits

Before leaving the subject of the choice of a circuit, it is perhaps only fair to those readers of greater experience upon the lower frequencies (longer wavelengths) to mention two other types of circuit which have very distinct advantages for short-wave work, but which are not suitable for the relative beginner. I refer to the super-regenerative circuit and to the super-heterodyne. With regard to the first of these, there is no doubt, of course, that it offers very great attractions indeed for short-wave work, but information is at present decidedly lacking as regards the practical details involved. This state of affairs will no doubt be remedied at an early date.

### Super-heterodynes

The super-heterodyne is a very delightful instrument to use upon the higher frequencies, since the extremely critical nature of the tuning and general adjustment

to secure the remarkable results of which this instrument is capable upon the higher frequencies also.

### A Practical Circuit

A circuit is given in Fig. 4 which will provide the basis for the necessary work, and this simple set will be found to operate satisfactorily with a very small amount of experimenting with the lay-out of the parts and so on. In the set illustrated only five valves are required, one of these being a separate oscillator using the Reinartz circuit. This latter arrangement I have found very useful for the separate oscillator on a short-wave super-heterodyne, the reaction condenser being a variable one, for the purpose of adjusting the circuit to suit different types of valves which may be used for the oscillator.

### The Separate Oscillator

Once set, the oscillator will generally cover quite a wide range of frequencies without requiring any readjustment of its reaction condenser. Any such readjustment, of course, should be avoided, since it upsets any calibration which may be attempted of the oscillator circuit. This oscillator circuit is coupled by means of two small pick-up coils, P1 and P2, to the grid circuit of the first detector. I have found three turns in each of these coils quite sufficient for most purposes, and they may be wound side by side upon the same piece of zin. tube. The turn numbers for the other inductances must, of course, depend upon the frequencies which it is proposed to receive. The aerial used with this set I have found should only be a few yards of wire, preferably hung across the ceiling of the room in which the instrument is being employed. The remainder of the circuit follows perfectly standard lines, and I have found it to work quite successfully with the ordinary input filter and intermediate transformers supplied by Messrs. Bowyer-Lowe for use in super-heterodynes arranged for broadcast reception.



# Jottings by the way

## Violence

"MR. WAYFARER," announced Poddleby's maid, ushering me into his drawing-room the other afternoon. As I stepped gracefully in preparing my company smile, I was just in time to see Poddleby and his better half collapse in a gasping heap in the midst of the floor. I rushed forward and seized Poddleby by the scruff of the neck. "Coward!" I cried, "to strike a woman. Good evening, Mrs. Poddleby. How are you? Still well, I hope, despite the cave-man treatment which I have just witnessed." When I had helped them both to their feet they started to explain, both talking at once, that what I had mistaken for a violent quarrel was really a tango. And then I noticed that the loud-

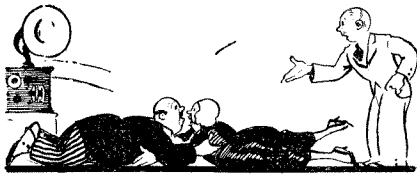

... "Coward!" I cried ...

speaker was saying something like "Advance the right foot in a north-easterly direction, turn slightly on the ball of the left, bringing the toe of the right-foot below the left knee. At the same time swing your partner gracefully round." And so on and so on.

## Dancing Lessons by Wireless

I had seen something about these dancing lessons by wireless, but being myself by far the best performer in Little Puddleton it had not occurred to me that I was in any need of them. Therefore I had not tuned in on such occasions as they were being given. Both Poddleby and Mrs. assured me that it was the very finest thing that had ever been invented by the fertile brains of the B.B.C. And would I mind just sitting down for five

minutes and smoking a cigarette whilst they went on with it? Being, as you know, always willing to oblige, I sat down and filled both my cigarette cases from Poddleby's box. I then selected the best cigar that I could find from his stock and settled down to watch.

## Tangoing

"A chasseur forward and then turn," said the voice. Poddleby and Mrs. charged down the room and would, I think, have executed a very creditable turn, had they not tripped simultaneously over the loud-speaker leads. As it was, they collapsed once more, whilst the loud-speaker joined them on the floor, deafening Poddleby by continuing to bawl into his ear in spite of its rough treatment. Your real dance enthusiast is not easily dismayed. Poddleby and Mrs. arose with my help, and having replaced the loud-speaker on top of the piano were at it again in a moment, whilst I returned to my chair making a mental note to bring a cigar case next time. During the last part of the lesson a slight misunderstanding occurred, the instructor having forgotten to mention to which partner he was referring when he said "advance the right foot smartly."

## A Misunderstanding

The pupils whose performance I was witnessing both obeyed with alacrity, and then proceeded to hop round the room separately each on one foot. This movement I applauded loudly as being quite one of the most interesting and novel steps for ballroom purposes that I had yet seen. Luckily for both of them the lesson came to an end by the time that they had ceased to hop, and we spent the rest of the time in less strenuous pursuits. "It is simply splendid," panted Poddleby, sinking on to the sofa, "and there is still something better to come. Have you heard that they are going to broadcast physical exercises?"

## "Physical Jerks"

I looked at him coldly. "Some years ago," I said, "there was a War, and if I remember right not the least of its horrors was a thing called 'physical jerks.' You got up in the early morning and had to run round and wave your arms and kick your legs about and do all sorts of hateful things at the bidding of a fellow with a bulging chest who wore a striped jersey. Thank you, Poddleby, I know all about physical exercises." "My dear chap," cried Poddleby, "just think how good they are for you. About half a dozen of us have agreed already to form a Physical Exercise Society and we are going to meet each morning to follow the instructions given by the loud-speaker. It will



... A fellow with a bulging chest ...

make new men of us." "If it will do that," I said. . . . Poddleby held up his hand. "Do not scoff," he begged. "We are going to regain the suppleness and vigour of youth. It would do you all the good in the world, my boy. You have simply got to join up and be one of us."

## An Idea

The suggestion set me thinking. My own perfect figure has little need of physical jerks to add to its beauty. But for fellows like Poddleby and a few others I could mention, this drilling idea seemed to be just what was wanted. "I tell you what," I said at length. "Why should we not get all the fellows at the wireless club to take up the scheme and have exercises



each morning in the club house?" "An inspiration," cried Poddleby. "Why of course we will. We are already the brainiest club in the country and shortly we will be the healthiest. Every one of us will go about vaulting over pianos and slapping people on the back, or pushing invalids in bathchairs at twenty miles an hour down the street. When he does things like that you know that a man is perfectly healthy. And when our little daily dose has got to work, we will probably surpass even these feats."

**The Club Agrees**

Next evening Poddleby and I attended a meeting of the wireless club and put our proposal before the members in honeyed words. Most of them agreed at once, though there was at first a little opposition from General Blood Thunderby, Admiral Whiskerton Cuttle and Bumbleby Brown—all of them, of course, fellows whose figures badly need a little paring down. However, we persuaded them before we had done, and by the time that meeting broke up every member of the club had solemnly promised to present himself at the hut suitably garbed at the appointed hour on the following Monday morning.

**We Make a Start**

I have always thought Monday a rotten kind of day, and my



... *Clad in a dressing-gown and a bowler hat* ...

opinion of it was confirmed in the early hours of the next one that came along, for my beauty sleep was rudely disturbed by Poddleby's application of a large wet sponge to my face. "Lazy beast," he said. "There you are, or rather there you were, snoring away when you ought to be up drinking in draughts of the glorious morning air. Jump up now and hurry down to the hut." I jumped up, not because I wanted to go to the hut, but because I did want to land Poddleby a straight left in the ribs. He dodged rather neatly and seizing my bedclothes dashed with them through the door. I tried crawling in between the two

mattresses, but the top one always kept slipping off. In the end I gave it up, garbed myself in a pair of tennis trousers and a sweater, and strolled down to the club house.

**Strange Attire**

On the way there I met Professor Goop clad in a dressing-gown and a bowler hat. He was carrying, I noticed, an umbrella and an attaché case. He told me that just as he was about to leave the house he could not quite think why he had got up so early, but it suddenly occurred to him that he was going to catch the early train to London. But for my intervention he would probably have done so. I steered him to the hut, where he pulled off the dressing gown and disclosed the bathing dress that had created such a sensation during our holiday at Trouville. Poddleby turned up in running shorts and a gym vest, whilst the other members of the club sported a variety of costumes ranging from pyjamas to plus fours. As the zero hour struck the loud-speaker was switched on and we prepared for action as instructed.

**Mishaps**

Our space was just a little bit cramped perhaps for some of the freer movements, but I do not think that General Blood Thunderby need have bitten my finger when on extending my arm smartly as ordered I found my hand in his mouth. However, I got my own back during the arm-swinging movements. All went very well as long as we were on our feet. What I was waiting for was the order to lie down, and sure enough it came before long. I can assure you that the sight of General Blood Thunderby and Poddleby lying side by side upon their backs and waving their legs in the air was one that I would not have missed for anything. But the best of it all was when we were instructed to turn upon our faces and to balance ourselves upon the tips of our toes and the palms of our hands with arms straight. From that point we had to lower our chins to the floor by bending our arms. Our stouter members made puffing and gasping noises as, with their joints creaking like watchmen's rattles, they strove to lower themselves with decorum. The General got down somehow the first time and managed to heave himself up again somehow afterwards. The second descent, however, defeated him. He brought his chin to the floor all right, but very

much more quickly than he intended, and his subsequent remarks drowned even the loud-speaker for a brief space. However, all things considered, our first *séance* passed off very well indeed, and everyone agreed that having once begun we must continue.

That afternoon, seeing the General gazing into the window of a wireless shop in the High Street, it occurred to me that I might as well display some evidence of my new-found health and strength.

**Energy**

Coming up behind him, I smote him heartily between the shoulder

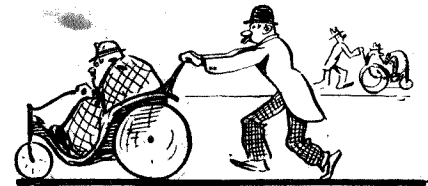

... *The members were in bathchairs* ...

blades. His leap into the air, though I doubt whether it would have cleared a piano, was quite creditable. On coming to earth he simply rounded on me. What the blue blazes did I mean by doing things like that? Didn't I know that he had got rheumatism in his shoulders and lumbago in his back and . . . I fled. I thought that I would go and see how Poddleby was getting on. I found him huddled in an armchair looking anything but vigorous. "Don't shake my hand too violently," he begged, "I am so stiff all over that I can hardly move." . . . That evening, just before the time appointed for the meeting of the wireless club, you might have seen a dozen bathchairs in the High Street. The members of the club were not pushing them at terrific speeds in order to show the world how vigorous they were. No, the members were in the bathchairs, being pushed.

**WIRELESS WAYFARER.**

SPECIAL BIRTHDAY  
NUMBER OF  
"The Wireless  
Constructor"  
OUT OCTOBER 15.  
124 PAGES  
PRICE 6d. AS USUAL.  
ORDER YOUR COPY EARLY

# Some Notes on Tuning and Selectivity

By J. H. REYNER, B.Sc. (Hons.), A.C.G.I., D.I.C.,  
Staff Editor.

A thorough investigation of the theoretical principles underlying selectivity, and their practical application will be dealt with in a series of articles by Mr. Reyner, of which this is the first.

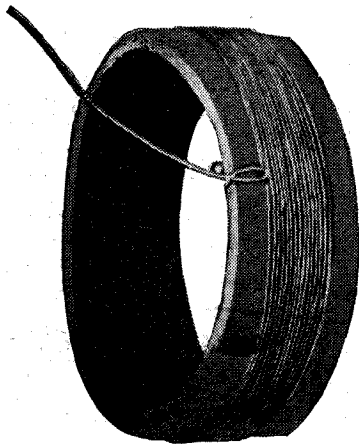

Are inductances of this type going to replace the existing shapes of coil?

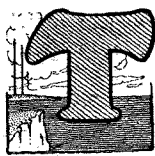

HE word "selectivity" has to-day an almost magical significance. The first test of any set is—how selective is it? Can it cut out London and receive Bournemouth or Cardiff? Mr. Harris in America was principally impressed by the remarkable tuning properties of the receiving apparatus in everyday use over there, and there is little doubt that the trend of development in this country is in the direction of improving the selectivity of the apparatus employed. It is proposed, therefore, to consider some of the aspects of tuning and selectivity generally, in order that investigators in this country may be assisted in the design of suitable circuits.

## Simple Tuned Circuit

Let us consider first of all a single circuit. If the circuit in Fig. 1 is connected to a source of supply of which the frequency is variable, then the actual current which will flow in the circuit depends upon the relation between the inductance and the capacity and the frequency of the applied E.M.F. The current is a maximum when the circuit is in tune with the E.M.F., that is to say, when the frequency is equal to  $\frac{1}{2\pi\sqrt{LC}}$ , L and C being the inductance and capacity in the circuit in henries and farads respectively.

As the frequency of the applied E.M.F. is varied, therefore, the current in the circuit will increase to a maximum at the tuning point and will then begin to decrease again, the current varying as indicated in Fig. 2, which is the well-known resonance curve.

## Resonance Curves

Now the nature of these resonance curves is an indication of the selectivity of the set. With a theoretical circuit having no resistance the resonance curve would be as shown in Fig. 3. That is to say, the current would be small until the resonant frequency was approached, when it would rapidly rise to an infinite value, falling again almost to nothing as the resonant frequency was passed. It was often thought that in a theoretical oscillatory circuit like this, having no resistance, the

current should be nothing until the resonant frequency was reached, at which point the current would suddenly grow to infinity.

## Circuit having no Resistance

This, however, is not the case. The current is controlled by the impedance in the circuit. Now the impedance is made up of a combination of the resistance and the reactance in the circuit, the actual expression for a circuit of this type being

$$Z = \sqrt{R^2 + \left(\omega L - \frac{1}{\omega C}\right)^2}$$

where  $\omega = 2\pi \times \text{frequency}$ .

Now if the resistance in the circuit is zero, this expression reduces to

$$Z = \omega L - \frac{1}{\omega C}$$

We see, therefore, that the impedance of the circuit is made up simply of the two reactances, one due to the inductance and the other due to the capacity. As the frequency is increased, so that  $\omega$  is also increased, the value of  $\omega L$  increases, and the value of  $\frac{1}{\omega C}$  decreases. At low frequencies the term  $\frac{1}{\omega C}$  swamps the term  $\omega L$ , and the total impedance in the circuit is very high. Towards the resonant value, however, the two terms become more or less equal and tend to cancel each other out. For a short while, therefore, the value of the impedance, which is equal to the difference between the two terms, has a comparatively

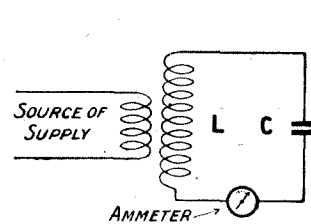

Fig. 1.—A simple series circuit.

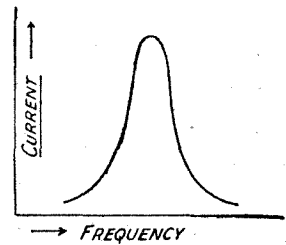

Fig. 2.—A typical resonance curve of a circuit such as is shown in fig. 1.

small value, and of course at the resonant point it falls to zero.

The current, being dependent upon the voltage divided by the impedance, will thus have a very small value under normal conditions, but will become appreciable near the resonant point and will rise to infinity actually at the tuning point. It will be seen, however, that the rise to the maximum value is gradual and not sudden even when the circuit has no resistance whatever. The curve shown in Fig. 3 is actually plotted



for a coil having an inductance of 100 microhenries and a capacity of 500 micro-microfarads.

**Effect of Inductance and Capacity**

We may now consider what effect on the resonance curve the various possible combinations of inductance and capacity will have. It is possible to construct a circuit to tune to a given frequency with a small inductance and a large capacity or vice versa. It therefore

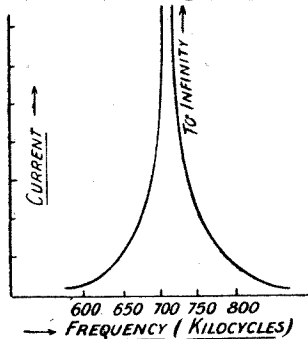

Fig. 3.—A resonance curve for a circuit having no resistance.

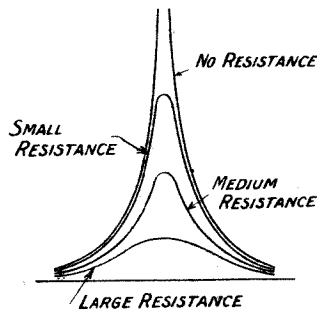

Fig. 4.—The effect of adding resistance is to decrease the current at each point.

remains to determine whether the relation between the inductance and the capacity has any effect upon the resonance curve.

When the circuit is in resonance the current will be infinite, irrespective of the proportion of inductance to capacity. At a small distance away from the resonant frequency, however, the current will fall to some finite value, and the smaller this value, the sharper will be the resonance curve. It can easily be shown that the current is inversely proportional to the capacity in the circuit, that is to say, the smaller the capacity, the smaller will be the current and consequently the sharper will be the resonance curve.

**Effect of Resistance**

So far we have simply considered circuits in which the resistance was zero. Let us now consider the effect of adding resistance to the circuit. The first effect is that the current at the tuning point instead

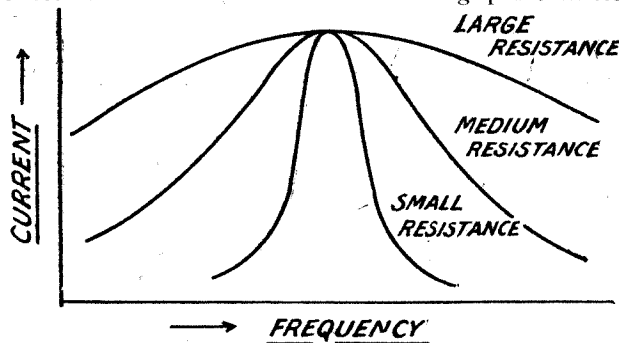

Fig. 5.—When drawn to a correct comparative scale, the addition of resistance can be seen to broaden the resonance curve.

of being infinite, is at once reduced to some finite value. Referring back, it will be seen that at the tuning point  $\omega L = \frac{1}{\omega C}$ . The total impedance of the circuit, however, is  $\sqrt{R^2 + \left(\omega L - \frac{1}{\omega C}\right)^2}$  which reduces simply to  $R$  when the circuit is in tune. Thus at the resonance point the current is given simply by  $\frac{E}{R}$ .

From this reasoning it will also be clear that at any frequency different from the resonant frequency the

current must be slightly less, now that the resistance is added, than in the previous resistanceless case. Consequently the resonance curve of a circuit containing resistance will lie *within* the theoretical resonance curve at every point, because the current at any given frequency must be less than in the theoretical resistanceless case.

Fig. 4 illustrates this point and shows several resonance curves with varying amount of resistance in circuit, and it will be seen that the successive curves all lie one within the other.

**Selectivity**

Now it will be obvious that the width of the resonance curves with varying amounts of resistance in circuit. A circuit in which the resonance curve falls very rapidly so that the curve itself is comparatively narrow will obviously be more selective than a circuit in which the curve only falls away comparatively slowly, so that the frequency has to be altered by a considerable amount before the current can be reduced to a small value. It would appear, however, from the reasoning which has just been stated that the effect of adding resistance to the circuit is to make the width of the

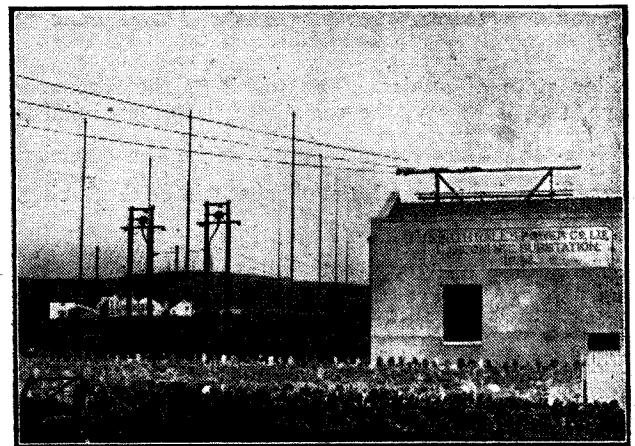

One of the power houses at the Carnarvon Wireless Station. The power is supplied from the town of Carnarvon and the two standards on the left of the photograph convey it on to the transmitting station.

resonance curve smaller and smaller, in other words, the circuit will become more and more selective as resistance is added.

**Band Width**

This, of course, is absolutely contrary to practice. The explanation is to be found in the matter of the scale. The selectivity is actually measured by the width of the resonance curve at a point such that the current is reduced to a definite fraction of the maximum value. Fig. 5 shows several curves of Fig. 4 all drawn out to a suitable scale such that the maximum values of the current are the same in each case. It will readily be seen from this figure that the effect of adding resistance is to broaden the resonance curve very considerably. If we measure the width of the resonance curve at a point such that the current is one-half the maximum value, it will be seen that this width is less, the smaller the resistance in the circuit.

The band width of a resonance curve is measured in terms of cycles per second, and is a very useful quantity. It defines the range of frequencies which is accepted by the particular circuit. This point will be

dealt with at a later stage. For the present it will suffice to note that the width of the resonance curve is proportional to the resistance and the quantity  $\sqrt{\frac{C}{L}}$

**Ratio of Inductance to Capacity**

We may now consider the effect of the ratio of inductance to capacity in a practical circuit. In the previous case we considered a circuit having no resistance, and we found that the smaller the capacity, the sharper was the tuning. In this case we have a very

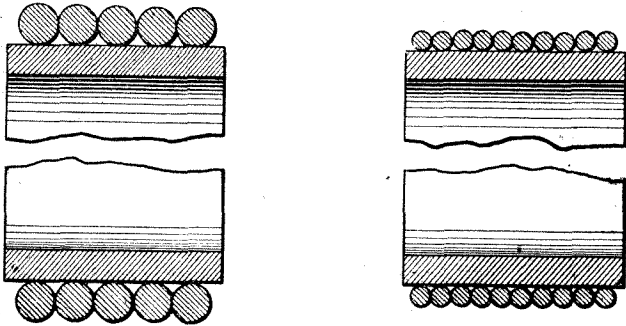

Fig. 6.—With a given shape of coil, to obtain a larger number of turns, a smaller gauge of wire must be used.

similar state of affairs. The width of the resonance curve, that is to say, the selectivity, is proportional to  $\sqrt{\frac{C}{L}}$ . Thus the smaller we make the capacity, other things being equal, the sharper will be the tuning.

**Effect on Selectivity**

Affairs, however, are not quite as simple as they seem. If we reduce the capacity in the circuit, we must of necessity increase the inductance in order to tune to the same frequency as before. This as a rule increases the resistance at the same time, and the effect is thus complicated. Let us assume for a moment that whatever coil we use, the ratio of resistance to inductance, i.e.,  $\frac{R}{L}$  remains constant. If now we halve the capacity we must double the inductance in order to tune to the same frequency. Thus the ratio  $\frac{C}{L}$  will be one-quarter of its original value and  $\sqrt{\frac{C}{L}}$  will be one-half its original value. On the other hand, as we have doubled the inductance, we have doubled the resistance, so that the band width remains exactly the same as before. Thus we see that on the assumptions we have made, the ratio of inductance to capacity has no effect upon the selectivity of the circuit.

**Resistance of Coils**

The ratio of resistance to inductance of coils, however, is not constant at high frequencies. In the case of a multi-layer coil carrying current at low frequency, so that the resistance is substantially the same of the D.C. resistance, that is, that there is no skin effect, it can be shown that the ratio of resistance to inductance is approximately constant for a given shape of coil, whatever the gauge of wire employed. In the case of a coil used at radio frequencies, however, this is no longer the case. In the first place, it is desirable to use single-layer coils wherever possible. A little thought will show that in a case like this the ratio of resistance to inductance is by no means constant.

**Single Layer Coils**

Let us assume that we have a coil of a given diameter and a given winding length. If we double the number of turns we shall obtain four times the inductance. The length of wire in the coil is now doubled, so that the resistance will be doubled. In order to get twice the number of turns in the coil, however, we have to use wire only half the previous diameter. This means that the area would be one-quarter of its previous value, so that the resistance will again be increased four times, the total increase of resistance being eight times. Thus the resistance is increased by this figure, while the inductance has increased only four times, so that the ratio of resistance to inductance is twice what it was in the former case.

A little thought will show that this reasoning also applies to spaced windings since the spacing employed depends on the diameter of the wire.

Against this must be placed the fact that with the thicker wire, as used in the first case, the skin effect will be somewhat greater, so that the high-frequency resistance in the second case may not be quite as much as eight times what it was in the first case. Experiments show, however, that down to a gauge as low as 18 or 20 s.w.g. there is a distinct improvement in single layer coils by using thicker wire. Thus for the best ratio of resistance to inductance, the inductance itself should be made small so that a comparatively few turns of thick wire may be used for the purpose.

Thus we see that in a practical case the conditions for obtaining maximum selectivity are that the coil should have a small inductance and should be tuned with a comparatively large capacity. This is the direct (Continued on page 123.)

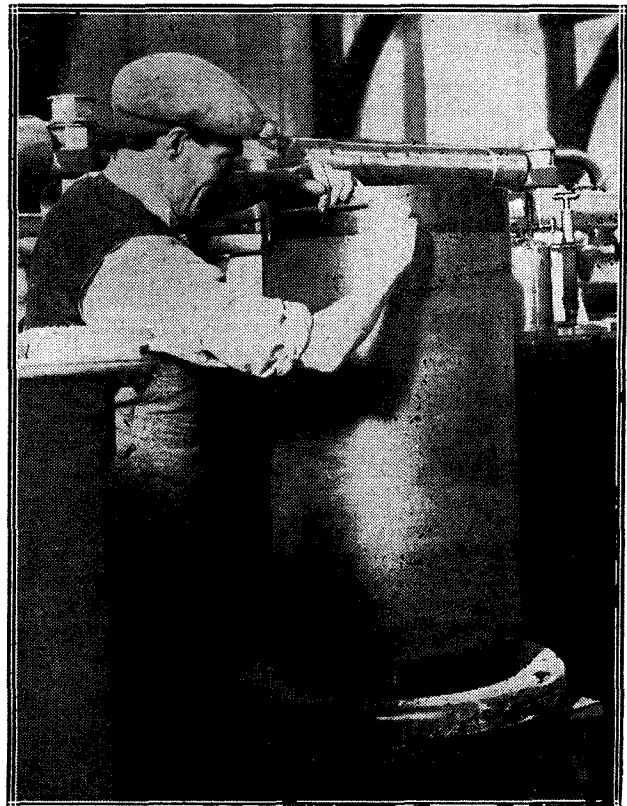

Making final adjustments to one of the coils at the Rugby Wireless Station.



# NEW BRITISH VALVES



Valve type L240.

WE are pleased to welcome into the general market a new valve factory which has been inaugurated by Burndeft Wireless, Ltd. The Managing Director is Mr. C. F. Trippe, whose name is well known in the valve world, as he has up to the present time been responsible for the design of a number of valves which have proved very popular; recently he resigned from the General Electric Co. to take charge of this new valve factory. Mr. Trippe has with him another notable wireless engineer, Squadron-Leader B. N. H. Hamilton, who recently resigned his commission with the Royal Air Force, where he held a responsible position in the Wireless Service.

A complete series of valves has been sent to us for test (the only satisfactory way and one which we would commend to other manufacturers submitting valves), and they cover the whole range of requirements for broadcasting reception.

### Nomenclature

For the eight different types of valves a nomenclature has been introduced, which makes it quite easy to recognise the general purpose of each valve. The symbols L and H followed by three figures are used. H distinguishes a high-frequency valve, and L a low-frequency valve. The use of both symbols, HL, indicates that the valve is a general-purpose valve. The first number indicates the filament voltage, and the second

An account of tests carried out at the Elstree Laboratories of Radio Press, Ltd., of the new series of valves produced by Messrs. Burndeft Wireless, Ltd., exhibited for the first time at the recent N.A.R.M.A.T. Wireless Exhibition.

and third numbers give the filament current. For instance, one valve is labelled L 240, the L indicating that this particular valve is a low-frequency valve. The three numbers, 240, indicate that the filament

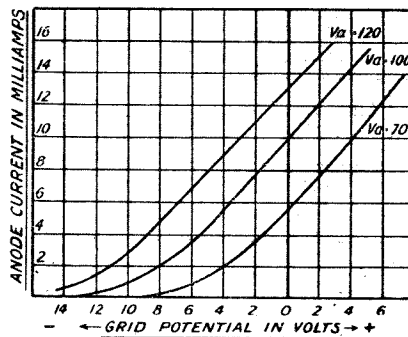

Fig. 1.—Characteristic curves of the L525 type of valve.

requires a potential of 2 volts and takes a current of 400 milliamperes.

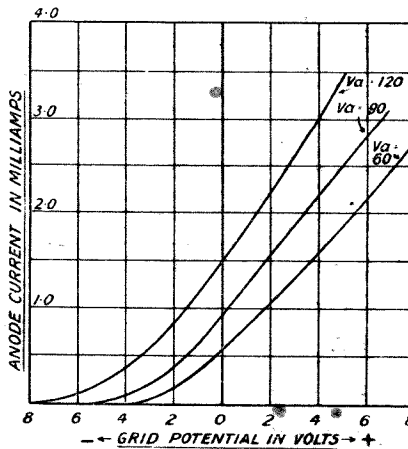

Fig. 2.—Characteristic curves of the valve type H310.

### Practical Tests

The complete series of eight valves have been tested on our valve test bench, and, further, the valves were used in some of the well-known Radio Press receivers and amplifiers. The results on the test bench are given in detail. It will be noted in each case that we give the filament potential and the filament current for comparison with the values recommended by



Valve type L550.

the manufacturers. In addition, the flash emission is given for a particular voltage on the grid and anode connected together. Then the circuit is closed for one or two seconds only, and the actual anode current measured. This is called the flash emission.

### Flash Emission

Flash emission gives an indication that the filament is capable of operating the valve under working conditions, but it must not be imagined that this anode current can be used. A flash emission test is useful for showing whether the valve is good as regards emission. Thus 10 milliamperes is a suitable value for most receiving valves apart from power valves. Another factor is given, which is the flash emission per filament watt. This is obtained by dividing the total flash emission by the number of watts consumed by the filament, the watts being the product of the volts and amperes on the filament.

In some cases more than one valve of each type was tested, and it was noticed that the valves amongst themselves were fairly uniform. The valves tested in the Radio Press sets gave very satisfactory results as regards volume and purity. One set in which they were tested was the "Harmony Four," in which it was possible to test all the types of valves.

**VALVE TYPE L240 (Dull Emitter).**

Filament Potential 1.9 V.  
Filament Current 0.4 A.

Flash Emission 20.0 mA.  
at 120 V.  
Flash Milliamps Emission per Filament  
Watt 26.3 mA.

| Anode Potential in volts. | Grid Potential in volts. | Anode Current in milliamps. | Amplification Ratio. | Internal Impedance in ohms. |
|---------------------------|--------------------------|-----------------------------|----------------------|-----------------------------|
| 60                        | -5.0                     | 2.75                        | 4.65                 | 10,500                      |
| 80                        | -7.0                     | 3.85                        | 4.90                 | 9,500                       |
| 110                       | -11.0                    | 5.15                        | 4.30                 | 9,500                       |

*Manufacturer's Rating.*

Filament Potential 1.8—2.0 V,  
Filament Current 0.4 A.  
Anode Potential 60—120 V.

**VALVE TYPE HL213 (Dull Emitter).**

Filament Potential 2.0 V.  
Filament Current 0.12 A.

Flash Emission 7.0 mA.  
at 100 V.  
Flash Milliamps Emission per Filament  
Watt 29.2 mA.

| Anode Potential in volts. | Grid Potential in volts. | Anode Current in milliamps. | Amplification Ratio. | Internal Impedance in ohms. |
|---------------------------|--------------------------|-----------------------------|----------------------|-----------------------------|
| 60                        | 0                        | 1.15                        | 6.9                  | 31,000                      |
| 80                        | -1.0                     | 1.5                         | 7.85                 | 28,600                      |
| 110                       | -3.0                     | 1.9                         | 8.6                  | 28,600                      |

*Manufacturer's Rating.*

Filament Potential 1.8—2.0 V,  
Filament Current 0.13 A.  
Anode Potential 40—100 V.

**VALVE TYPE H310 (Dull Emitter).**

Filament Potential 3.0 V.  
Filament Current 0.1 A.

Flash Emission 14 mA.  
at 150 V.  
Flash Milliamps Emission per Filament  
Watt 46.7 mA.

| Anode Potential in volts. | Grid Potential in volts. | Anode Current in milliamps. | Amplification Ratio. | Internal Impedance in ohms. |
|---------------------------|--------------------------|-----------------------------|----------------------|-----------------------------|
| 60                        | -0.5                     | 0.42                        | 16.5                 | 83,000                      |
| 80                        | 0                        | 0.825                       | 17.6                 | 60,000                      |
| 110                       | -1.0                     | 1.05                        | 13.0                 | 50,000                      |

*Manufacturer's Rating.*

Filament Potential 2.8—3 V,  
Filament Current 0.1 A.  
Anode Potential 40—150 V.

**VALVE TYPE H512 (Dull Emitter).**

Filament Potential 5.0 V.  
Filament Current 0.12 A.

Flash Emission 24.0 mA.  
at 150 V.  
Flash Milliamps Emission per Filament  
Watt 40 mA.

| Anode Potential in volts. | Grid Potential in volts. | Anode Current in milliamps. | Amplification Ratio. | Internal Impedance in ohms. |
|---------------------------|--------------------------|-----------------------------|----------------------|-----------------------------|
| 60                        | -1.0                     | 0.635                       | 13.5                 | 50,000                      |
| 80                        | -0.5                     | 1.4                         | 15                   | 33,400                      |
| 110                       | -1.5                     | 1.75                        | 14.3                 | 28,600                      |

*Manufacturer's Rating.*

Filament Potential 4.5—5.0 V.  
Filament Current 0.12 A.  
Anode Potential 40—150 V.

The valves are nearly all of the dull-emitter type, but in spite of this, microphonic noises were not noticeable on the whole, being slightly perceptible in the L 240, but rather bad in the HL 213. The life of the valves has not been tested.

**General Remarks**

The valves, as will be observed from the photographs, have a good

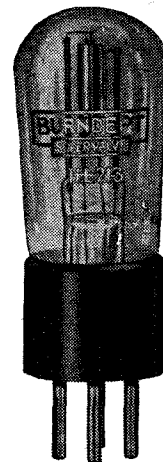

Valve type HL213.

appearance. As far as can be seen through the walls of the valves, which in all cases shows signs of a getter, the anodes are very small, and most of them appear to be of the oval type, this apparently being to allow a loop filament to be used and a lower impedance to be secured. The smallness of the

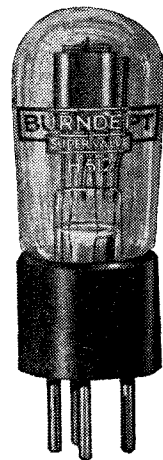

Valve type H512.

anode is very pronounced in all cases. This smallness of the anode, however, is obviously good for obtaining low impedance, but there will be the danger that the filament may touch the grid in some samples.

The valves can be distinguished by the letters R.A.L., which represents Radio Accessories, Ltd., the firm formed by Burndept Wireless, Ltd., for the manufacture of valves.

A point in which some improvement seems desirable is the marking of the valves in accordance with the scheme of letters and figures described. In the samples submitted these markings, which are placed on the glass

Valve type HL310.



bulb of the valves, were somewhat indistinct.

As regards the cap, this is made of bakelite, with a ridge to indicate the position of the anode pin. The pins in most cases required opening out before they would fit closely in the holders. The general result of our tests shows that, as was to be expected, the new factory has produced a very good series of valves which readers of our journals can purchase without any hesitation.

Valve type L525.



Another important point to notice is that in the whole of this series of valves the filament current is never less than 100 milliamperes. This, we believe, is done with a definite purpose in order to secure a definite filament tension, and thus ensure uniformity in the characteristics. The filaments are nearly all thoriated.

**VALVE TYPE HL512 (Dull Emitter).**

Filament Potential 5.0 V.  
 Filament Current 0.1 A.  
 Flash Emission 20 mA. at 100 V.  
 Flash Milliamps Emission per Filament Watt 40 mA.

| Anode Potential in volts. | Grid Potential in volts. | Anode Current in milliamps. | Amplification Ratio. | Internal Impedance in ohms. |
|---------------------------|--------------------------|-----------------------------|----------------------|-----------------------------|
| 60                        | -1.0                     | 1.75                        | 9.15                 | 16,700                      |
| 80                        | -0.25                    | 2.25                        | 8.1                  | 15,400                      |
| 110                       | -4.0                     | 3.4                         | 8.22                 | 13,150                      |

*Manufacturer's Rating.*

Filament Potential 4.5—5.0 V.  
 Filament Current 0.12 A.  
 Anode Potential 40—100 V.

**VALVE TYPE HL310 (Dull Emitter).**

Filament Potential 3.0 V.  
 Filament Current 0.1 A.  
 Flash Emission 8.5 mA. at 100 V.  
 Flash Milliamps Emission per Filament Watt 28.3 mA.

| Anode Potential in volts. | Grid Potential in volts. | Anode Current in milliamps. | Amplification Ratio. | Internal Impedance in ohms. |
|---------------------------|--------------------------|-----------------------------|----------------------|-----------------------------|
| 60                        | -2.0                     | 1.85                        | 5.78                 | 17,300                      |
| 80                        | -4.0                     | 2.4                         | 5.5                  | 16,800                      |
| 110                       | -7.0                     | 3.11                        | 5.55                 | 17,100                      |

*Manufacturer's Rating.*

Filament Potential 2.8—3.0 V.  
 Filament Current 0.10 A.  
 Anode Potential 40—100 V.

**VALVE TYPE HL565 (Bright Emitter).**

Filament Potential 5.0 V.  
 Filament Current 0.63 A.  
 Flash Emission 13.0 mA. at 100 V.  
 Flash Milliamps Emission per Filament Watt 4.12 mA.

| Anode Potential in volts. | Grid Potential in volts. | Anode Current in milliamps. | Amplification Ratio. | Internal Impedance in ohms. |
|---------------------------|--------------------------|-----------------------------|----------------------|-----------------------------|
| 60                        | -1.0                     | 1.23                        | 9.25                 | 30,800                      |
| 80                        | -2.0                     | 1.6                         | 10.0                 | 28,600                      |
| 110                       | -4.0                     | 2.0                         | 9.75                 | 25,600                      |

*Manufacturer's Rating.*

Filament Potential 4.5—5.0 V.  
 Filament Current 0.65 A.  
 Anode Potential 40—100 V.

**VALVE TYPE L525 (Dull Emitter).**

Filament Potential 5.0 V.  
 Filament Current 0.22 A.  
 Flash Emission 35 mA. at 150 V.  
 Flash Milliamps Emission per Filament Watt 31.8 mA.

| Anode Potential in volts. | Grid Potential in volts. | Anode Current in milliamps. | Amplification Ratio. | Internal Impedance in ohms. |
|---------------------------|--------------------------|-----------------------------|----------------------|-----------------------------|
| 60                        | -2.0                     | 2.63                        | 7.65                 | 8,510                       |
| 80                        | -3.0                     | 4.35                        | 7.94                 | 6,930                       |
| 110                       | -6.0                     | 5.6                         | 6.65                 | 6,340                       |

*Manufacturer's Rating.*

Filament Potential 4.5—5.0 V.  
 Filament Current 0.25 A.  
 Anode Potential 90—150 V.



# Appointment of Mr. H. J. Barton-Chapple,

*Wh.Sch., B.Sc. (Hons.), A.C.G.I., D.I.C., A.M.I.E.E.,  
to the Staff of Radio Press, Ltd.*

**I**T is with great pleasure that we introduce to our many readers Mr. H. J. Barton-Chapple, who recently joined the senior technical staff of Radio Press, Ltd., as the outcome of our development policy in connection with the Research Laboratories at Elstree.

### Qualifications

He is possessed of high qualifications, largely as the outcome of a particularly successful career. Before entering the City and Guilds (Engineering) College, Mr. Barton-Chapple secured a Whitworth Scholarship, which stands pre-eminent amongst open competitive scholarships in the United Kingdom owing to the high standard of the examination and the rigid conditions for competing.

On entering College in 1919 he passed straight into the second year, and at the final examination

of the third year secured the Associateship of the City and Guilds of London Institute (A.C.G.I.), heading the list of successful candidates, and, as a result, securing the Siemens Memorial Medal. He also obtained the Henrici Medal for Mathematics, being the student of greatest merit in this subject. In the same year Mr. Barton-Chapple graduated at the University of London, obtaining the B.Sc. degree in Electrical Engineering with first class honours.

This was followed by a four-year post graduate course in radio telephony and telegraphy under Professor Howe, on the successful completion of which he was awarded the Diploma of Membership of the Imperial College of Science and Technology (D.I.C.).

### Further Experience

On leaving College in 1922 Mr. Barton-Chapple was appointed Lecturer in Electrical Engineering



*Mr. H. J. Barton-Chapple.*

(specialising in high-frequency and thermionic valve work) at the Bradford Technical College. Since that time he has conducted classes in electrical and radio engineering, being entirely responsible for the courses in the latter subject, and his efforts have met with particular success.

His duties brought him into intimate contact with every type of student, whereby much experience was gained in elucidating problems in such a manner that students were able to secure a clear conception of the normally intricate points.

### Practical Research

Mr. Barton-Chapple has had considerable opportunity for research work, and several articles on the results of such investigations have appeared from time to time in the technical Press.

While at Bradford Technical College he was elected an Associate Member of the Institution of Electrical Engineers (A.M.I.E.E.), a distinction which, as our readers know, is of a distinctly valuable character.

Our readers, therefore, may look forward to some very helpful articles from Mr. Barton-Chapple's pen, many of which will be the outcome of research work at our new laboratories which are now in full swing.

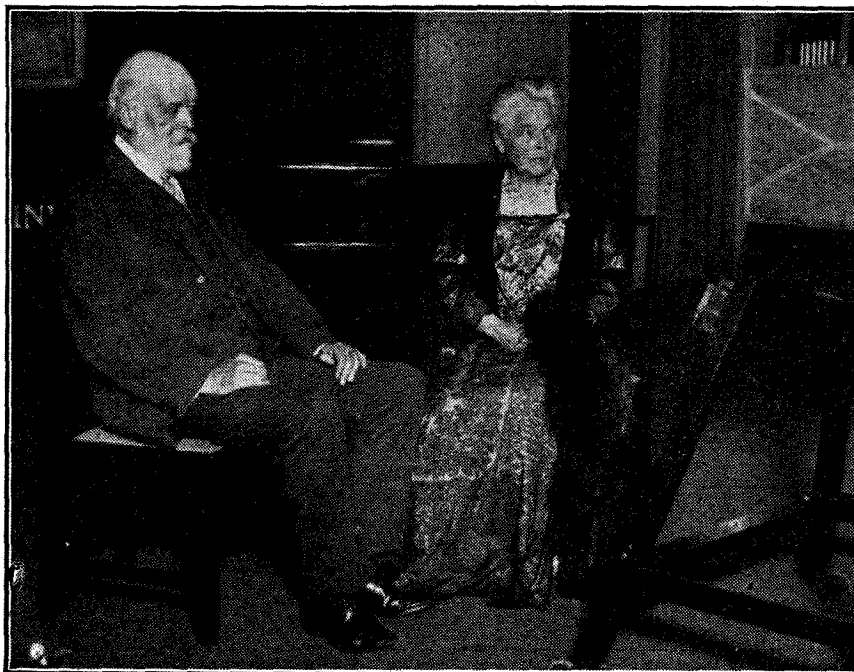

*Dame Henrietta Barnett, D.B.E., and Sir Oliver Lodge, who recently broadcast a talk from the London Station on "The Things that Matter."*

# A LOUD-SPEAKER CIRCUIT FOR THE LOCAL STATION

By A. D. COWPER, M.Sc., Staff Editor.

*It is often convenient to have a receiver which can be switched on at any time for the reception of local broadcasting, as distinct from long-distance reception, and the circuit described here will no doubt fulfil the requirements in this direction of many readers.*

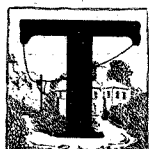

THOSE whose main interest in radio lies in the reception of the local station's transmissions at comfortable strength, with really good quality of reproduction and with the minimum of trouble, will find in the circuit described here a solution of their problem. Even the more experienced investigator might find such a receiver useful as a standby, and to fulfil family requirements in everyday broadcast reception. It does not in the least pretend to be a circuit for long-distance work, nor does it possess striking selectivity, having merely that of any loose-coupled circuit, *i.e.*, enough to minimise any but the worst of local interference when receiving the local station. There is but one tuning control, and that not critical, whilst the tuning is, to a large extent, independent of the aerial characteristics. No reaction is used; the receiver is unable to howl or oscillate, whilst the fixed or semi-permanent crystal detector used will require the very minimum of attention when once set.

## Components

Small power valves are used (or a D.E.5B or similar valve and a small power valve), together with ample H.T. and grid bias in order to obtain distortionless reproduction of good volume. One (high-ratio) L.F. inter-valve transformer is specified, which should be of the modern large heavy pattern, with plenty of iron and copper in it, and a section-wound secondary. No appreciable distortion need be feared if the right type of transformer is used here. As the H.T. demands are fairly severe, even when grid bias is used, a small H.T. accumulator of 120 volts should be used: a number of patterns are now available on the market. The loud-speaker windings are protected from the heavy D.C. plate current by the usual device of a choke-capacity filter coupling.

## Potential Rectifier

It will be noticed that the crystal detector is used as an almost purely *potential* rectifier, being connected directly in series with the grid of the first (L.F. amplifying) valve. This is an old device, dating from the earliest stages of thermionic valve practice. It has been revived lately in America by H. Gernsback under the (characteristic American) name of the "Interflex" circuit—though it has nothing whatever to do with "reflex" circuits.

Recent work, however, has elucidated the remarkable fact that a crystal detector operates with quite high efficiency in this kind of arrangement, where there is very little D.C. current flowing at all in the circuit, and it is mainly a matter of voltage.

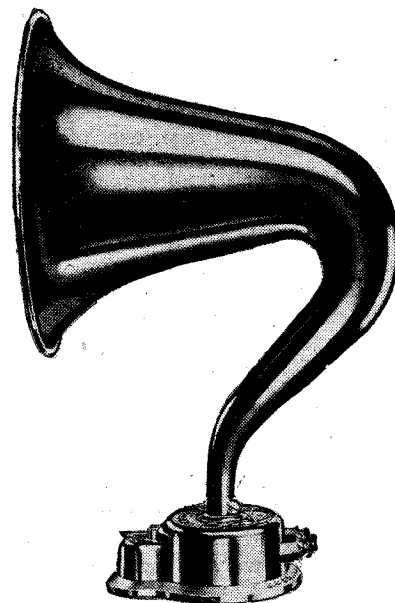

## Damping

The present writer lately investigated the matter in a practical manner, with a view to obtaining, if possible, the less heavily damped rectifying device than the ordinary crystal, or a rectifying valve operating with grid condenser and grid-leak; and with this in view he tried the effect of an ample *negative* grid bias on the valve following the detector, so that practically no grid current could flow at all, and therefore energy losses should be a minimum. Unfortunately, however, practical experiment showed that, although an appreciably higher audio signal strength resulted from the combination of potential rectifying crystal and power

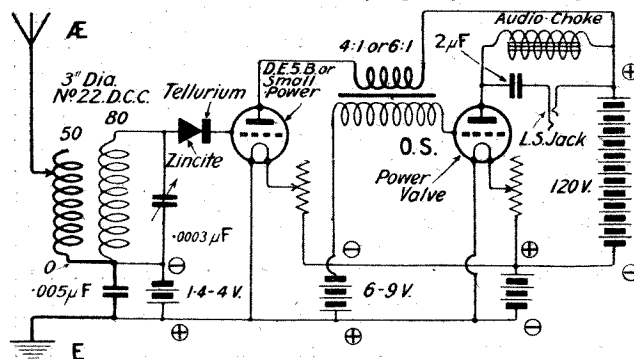

**Fig. 1.—The circuit of the set described. It is important that the crystals of the detector be placed in the positions shown here, the zincite being nearest to the grid coil.**

amplifying valve than with the same valve operating as a detector without reaction, either with a grid condenser and leak or on the anode characteristic bend, the grid circuit was nevertheless heavily damped by the combination. Since (if the crystal is operating properly) no useful reaction effects can be obtained, the combination is not suitable for distant reception or critical work.

**Purity**

A redeeming feature of the potential rectifying combination was found, however, in the great ease with which exceptional purity and fidelity of reproduction could be obtained from the local station's transmissions of fair power. Given a reasonably high signal voltage so that the crystal detector is operating on a portion of its characteristic which is practically linear, the completely aperiodic nature of the first valve coupling, combined with the use of a valve which will safely handle the power, ensures signals of a purity which will be found quite comparable with those from the crystal alone, but with quite a fair degree of amplification due to the first valve. By using a modern large L.F. intervalve transformer with ample primary impedance and a section-wound secondary, together with a second power valve, little further distortion is introduced: the practical limit is set, at present, by the fidelity of reproduction by the loud-speaker equipment rather than transformer distortion.

**Power Valves**

It is of little use to provide for purity of reproduction elsewhere if valves are used (as is so often the case, even in professional demonstrations), which cannot handle the power. Horrible distortion results from

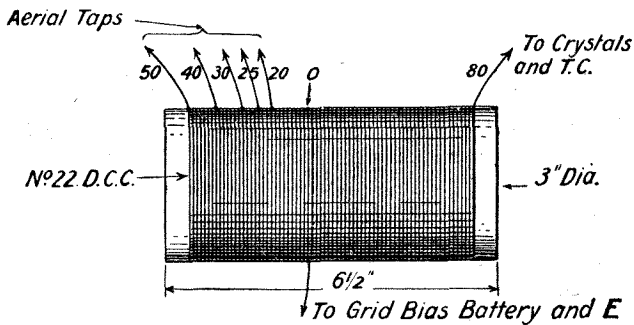

Fig. 2.—The aerial and grid coils are wound on one former with a common earth tapping.

overrunning the characteristic of the valve in such a case. With a large outside aerial in the suburban area, or with a small outside or an efficient indoor one of good dimensions very close in to a station, the signal voltage applied to the first valve may easily be more than an ordinary L.F. amplifying valve (or the D.E.5B valve, that would otherwise be chosen for its high amplification factor) can carry, without flattening the peaks of some of the wave-forms: in such a case a power valve should be used here, such as the D.E.5, the D.E.5A, the P.V.6, or others of the same class of low-impedance valves, and ample H.T. and grid bias should be applied. A less effective aerial, or a suburban indoor one, calls for a D.E.5B or D.E.3B (or similar) valve of high amplification factor and moderate impedance.

**Makes of Components Used**

The call for a valve of ample power is still more urgent in the case of the second L.F. amplifier: a low-impedance valve with generous grid bias and full 120 volts H.T. must be used here. The writer found good results on his high suburban aerial with two valves of the 5/.25 class operated in parallel here, following a single valve of the same type in the first position, all with 120 volts H.T. and with 9 and 4 volts grid bias respectively. The result was

a full-throated loud-speaker shout of a clarity and faithfulness of reproduction falling very little short of that which the crystal alone gave on the same loud-speaker (but, of course, at a very much lower intensity

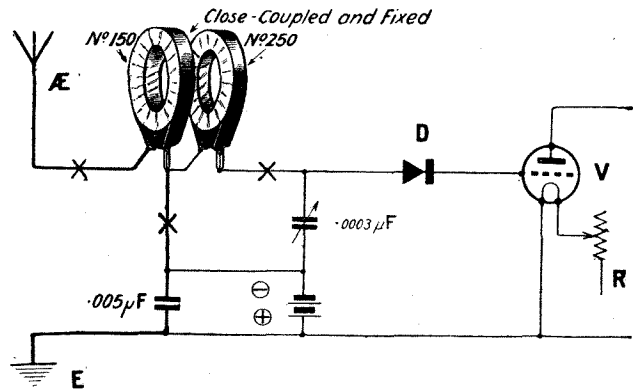
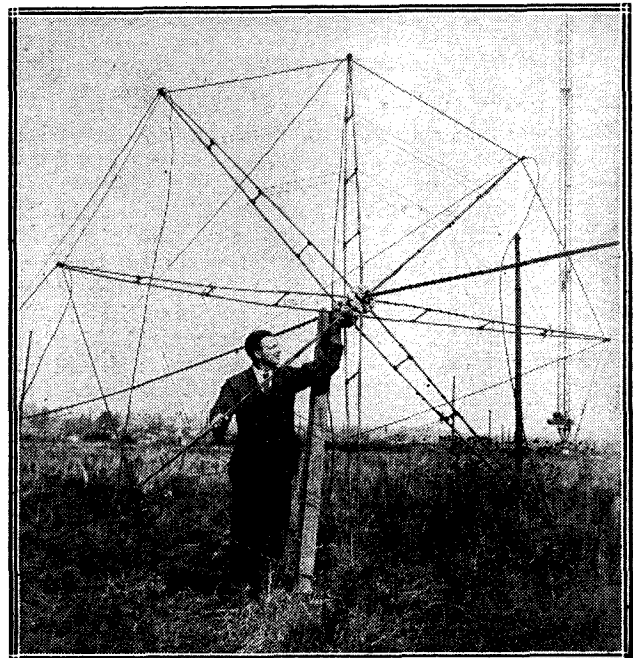

Fig. 3.—The arrangement of coils recommended by the author for the reception of Daventry. Switches for changing over may be inserted at the points marked X.

in that case). The main criticism called for was that there was a slight general lowering of "pitch," but sibilants were much clearer than usual, and speech very natural. This was with a Marconi Ideal 4:1 transformer, Ediswan Dulcivox loud-speaker base, and Scientific Supply Stores non-resonant loud-speaker trumpet, with a Grafton Electric Co.'s audio-choke and H.T. accumulator battery. A low single-wire aerial,



The spreaders for the aerial at the Government Wireless Station at Hillmorton, near Rugby, are of imposing size.

or an indoor attic aerial, at 12 miles, gave with a D.E.5B valve (1.4 volts grid bias) and a single power valve following it moderate loud-speaking of great purity, which would suffice in intensity for an intimate audience.



### Constructional Notes

The aerial coupler is of the "semi-aperiodic" type, with a simple tapped solenoid coil of mediocre design (to correspond with the fairly high damping present). Five alternative tappings are provided for the aerial connection, the optimum being found by simple experiment; excess turns can be removed later. The grid-coil has 80 turns of No. 22 d.c.c. wire close-wound, on a dry cardboard (or low-loss) former about 3 in. in diameter. This will tune over the usual short-wave broadcast belt with a .0003  $\mu$ F parallel tuning condenser. The 50-turn tapped primary coil is wound on the same former continuously with the secondary, as shown in Fig. 2.

### Crystal Detector

The crystal detector should be of the two-crystal or perikon type, and should be connected the right way round. An excellent stable combination is that of tellurium-synthetic zincite (*i.e.*, fused zinc oxide); one of the modern semi-permanent detectors with a certain degree of adjustability should be used here. A "Max-tone" Auto-Detector operated well in the circuit, and the "R.M.C." is also very suitable. The tellurium (or bornite) crystal should be next to the grid; if a galena combination is used—at some sacrifice of stability—the whisker should be on the aerial side and the galena next to the grid.

A grid-bias battery of 1.4 to 4 volts must be provided for the first grid, and should be bridged by a large fixed condenser of, *e.g.*, .005  $\mu$ F capacity, as shown in Fig. 1. The rest of the circuit follows current power amplifier practice, and calls for no comment.

### Simplicity of Operation

Once a good stable setting is found on the detector, the receiver needs no further attention other than switching on the current for use, and replenishing the batteries when required. An occasional touch to the tuning handle to follow up the vagaries of the local station's frequency standard, or the effect of sagging of the aerial, etc., may sometimes be required. This should not be entrusted to the unskilled: no daily "searching" is required.

It is obvious that the high-powered station can be provided for in the same receiver by introducing two fixed coil plugs arranged 1 in. apart, with a No. 150 aerial coil and a No. 250 secondary coil, together with a simple multiple change-over switch. This arrangement is indicated in Fig. 3.

## SOME NOTES ON TUNING AND SELECTIVITY

(Continued from page 116)

opposite of the theoretical case of a coil having no resistance, and, moreover, is rather contrary to generally accepted ideas of to-day. There is, of course, a limit to the decrease in the inductance of the coil. It is worth remembering, however, that it is comparatively easy to make a condenser having a very small loss, something less than 1 ohm, whereas the construction of a coil to have a resistance of as low as 5 ohms is a comparatively difficult matter. Low-loss coils can be wound by using special and expensive methods of construction, or they may be obtained by using only a few turns and a comparatively small inductance.

It would appear that this latter alternative is one which has not been given satisfactory trial. One disadvantage of the method lies in the fact that the voltage developed across the condenser is small. This, however, is offset to some extent by the fact that the current in the circuit is able to build up to a larger value owing to the lower resistance. There is obviously a practical compromise depending upon the type of circuit used, and it certainly seems that this method of obtaining selectivity could be explored with advantage.

### Use of Reaction

With judicious application of reaction it is possible to reduce the resistance of a tuned circuit to a comparatively small value. This, of course, improves the selectivity, and sharpens the resonance curve, but the action is not always clearly understood:

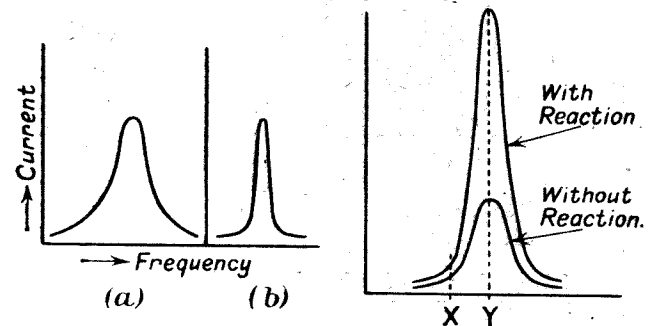

Fig. 7.

Fig. 8.

Reaction by itself does not reduce the unwanted signal, but actually causes an increase of current at each point of the curve.

Fig. 7 (a) is a resonance curve of an ordinary circuit containing a fair amount of resistance. The generally accepted idea is that the application of reaction will transform this resonance curve into something of the order shown in Fig. 7 (b), that is to say, a very thin curve having a very sharp cut-off.

Now this is true to a certain extent only. The effect of applying the reaction is to reduce the resistance in the circuit. This, therefore, is the exact contrast of the condition of affairs shown in Fig. 4. The new resonance curve with the reduced resistance will be as shown in Fig. 8. The more the resistance is reduced, the higher becomes the peak of the resonance curve.

The point to be noted is that as long as the input remains the same, the current at all points of the curve is increased. Thus, if we have an interfering signal at the point X, the application of reaction will cause, if anything, a slight increase in the value of this signal. It will at the same time cause a very large increase in the strength of the wanted signal, Y, due to the sharpening of the resonance curve, and the ratio between the wanted signal and the interfering signal will be reduced.

It very often happens, however, that the simple application of reaction, resulting in the increase of the wanted signals, does not give the desired effect because the interfering signal can still be heard. To obtain the resonance curve one desires, it is necessary to reduce the input of energy somewhat by loosening the aerial coupling or by making some other appropriate adjustment.

It should not be thought, however, that the application of reaction by itself can cause any diminution in the interfering signals; it can only cause an alteration of the ratio between the wanted signal and the interfering one.

# The Wireless Exhibition

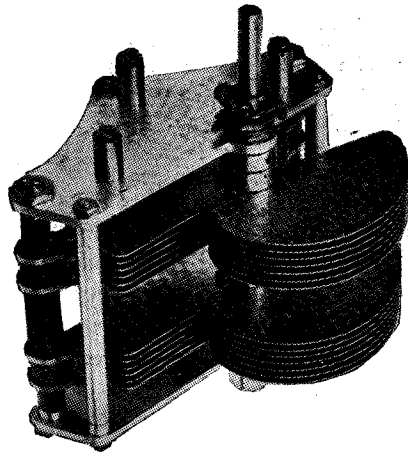

*The dual square-law low-loss condenser produced by the Igranic Electric Co., Ltd.*



GENERAL review of the exhibits at the Horticultural Hall shows that considerable progress has been made since last year, this being apparent in the appearance and finish of the components and complete receivers displayed, as well as in the design of the apparatus.

Several examples of super-heterodyne receivers are being shown, the Western Electric Co., Ltd. (Stands Nos. 37, 38 and 39) exhibiting a seven-valve set of this type. Ease of control is a feature of this

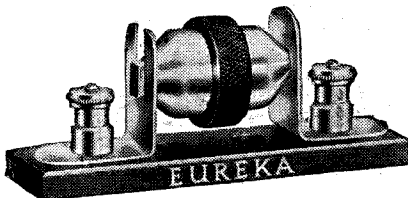

*The Eureka Gravity detector being shown by Portable Utilities Co., Ltd.*

receiver, while considerable selectivity and sensitiveness are claimed for it when used with the frame aerial advised. Prominent among this firm's range of products will be seen the Kone loud-speaker. It is claimed that this instrument gives extremely good quality reproduc-

The Exhibition will be open from 11 a.m. to 10 p.m. each day until October 16.

tion, responding equally well to both high and low notes, and that it will handle quite a large amount of power.

An eight-valve super-heterodyne receiver is shown by Peter Curtis, Ltd. (Stands Nos. 27, 28 and 29), which is claimed to incorporate certain novel features which have not previously appeared in a super-

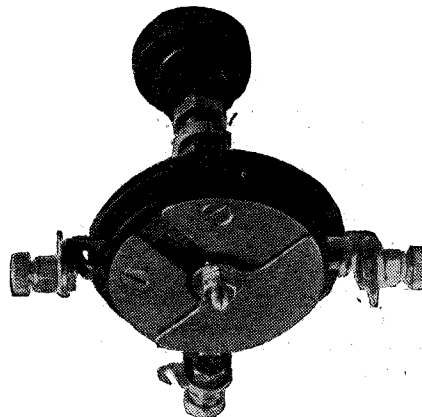

*The Igranic Electric Co., Ltd., are showing a vernier balancing condenser.*

heterodyne. In addition to this receiver and a wide range of receiving sets employing from two to five valves, the well-known Paragon guaranteed ebonite panels are being exhibited, together with aperiodic H.F. transformers and other components. A Duodyne receiver, made by Messrs. Peter Curtis, Ltd., is being used for the reproduction of the B.B.C. programmes during the period of the Exhibition, in association with Messrs. S. G. Brown, Ltd. (Stands Nos. 9, 10 and 11), who are exhibiting their full range of loud-speakers.

Among the complete receivers

*In our last issue we gave a their Stand Nos. at the Win with a plan of the Horticult general survey of some of th to be seen at th*

shown by the Fellows Magneto Co., Ltd. (Stands Nos. 12, 17, 18 and 23), are two of their latest models, the Two-Valve Grand and Four-Valve Grand, which are fitted in finely-finished cabinets of antique design. In addition to a display of bright- and dull-emitter valves, there are also to be seen the "Volu-tone" and "Junior" loud-speakers. Among the components shown on these stands notable features are a set of interchangeable coils for covering a wide range of wavelengths, and a new accumulator charger to work from A.C. mains.

An interesting exhibit by Messrs. M.P.A. (Wireless), Ltd. (Stands Nos. 15 and 16), is a five-valve receiver, which employs the neutrodyne method of stabilising the H.F. valves. The M.P.A. "Three" is a self-contained receiver working on a frame aerial in the lid, which is said to operate a loud-speaker successfully at 15 miles from a main broadcasting station. Other exhibits include the "Celestion" hornless loud-speaker, which is claimed to give excellent reproduction, free from resonance and metallic noises.

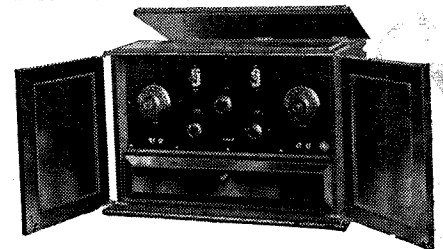

*The "Rotola III," a 3-valve receiver shown by Rotax, Ltd.*

The Radi-Arc Electrical Co., Ltd. (Stand No. 22), are also among those showing super-hetero-

# at the Horticultural Hall

**List of the exhibitors and  
less Exhibition, together  
Hall. We give here a  
latest types of apparatus  
Exhibition.**

**The Horticultural Hall is  
easily reached from St. James'  
Park or Victoria Underground  
Stations, and is well served by  
'buses.**

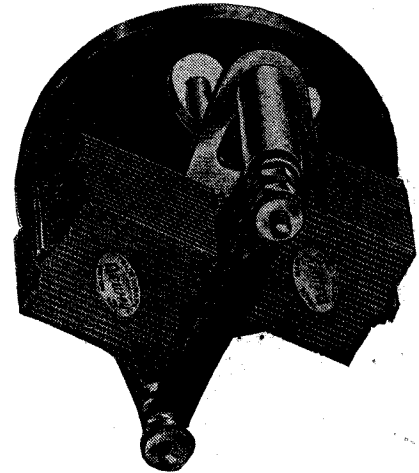

**Pettigrew & Merriman, Ltd., are exhibiting their Newey 4-point square-law condenser.**

dyne receivers, their "Liberty" sets of this class being designed to work with standard dull-emitter valves. Other features on this stand are a permanent crystal detector, and a safety wander plug incorporating a current-limiting device which is said to protect the valve filaments in case wrong connections are made, or the H.T. battery from short circuit.

The Seagull Four-Valve De Luxe Receiver, shown by Seagull, Ltd. (Stand No. 24), incorporates their low-loss tuner and choke-capacity coupling; these components are said to give a considerable measure of selectivity and freedom from distortion.

Together with standard two- and three-valve sets, the Engineering Works (Electrical and General), Ltd. (Stand No. 70), have on view their "Radiopal" four-valve receiver, which is contained in an attaché case, together with all the necessary accessories. Interchangeable frame aerials are provided, whereby reception is claimed to be possible at good loud-speaker strength from a main broadcasting

mains for supplying their receivers is made by Read & Morris, Ltd. (Stand No. 72). In particular a four-valve set, as supplied to a London hospital, is shown with one-knob control; by means of an adapter, which may be plugged into any convenient lamp-holder, both H.T. and L.T. are drawn from the A.C. lighting mains.

The British Engineering Products Co. (Stand No. 51), suppliers of

teries is also to be seen on these stands.

The exhibits by the Silvertown Co. (Stands Nos. 46 and 47) consist of the whole of the wide range of this firm's accessories, which include the "Silvervox" loud-speaker and a number of types of L.F. and H.F. transformers, some of the former having two centre tappings, brought out for use in the "push-pull" method of amplification.

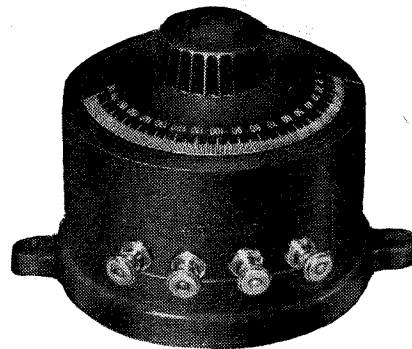

**A tuned H.F. transformer exhibited by Bretwood, Ltd.**

the "Tonyphone" range of receivers, are showing a number of these sets, an example being a one-valve receiver designed to operate headphones up to a distance of 500 miles from a main broadcasting station. A portable self-contained three-valve set is also shown, with which no external aerial or earth is required. Another portable set of interest is a two-valve reflex set shown by Messrs. Rotax, Ltd. (Stands Nos. 35 and 36), in which only one control knob is necessary; good stability and a headphone range of 25 to 30 miles are among the claims for this receiver. A full range of accumulators and dry bat-

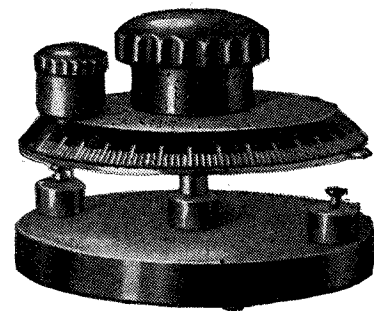

**A variable condenser with mica dielectric shown by Bretwood, Ltd.**

A number of new items which should prove of interest are being shown by the Igranic Electric Co., Ltd. (Stands Nos. 32 and 33). Among these items what will perhaps attract most attention is a six-valve supersonic heterodyne outfit for the home constructor, which includes a specially designed Igranic

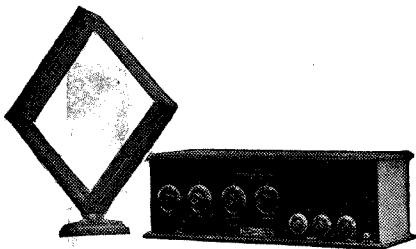

**A super-heterodyne receiver shown by the Radi-Arc Electrical Co., Ltd.**

station at 40 miles, or from Daven-

try at 120 miles, range.

Provision for using A.C. or D.C.



self-stabilising reactance unit. Another line of interesting exhibits comprises apparatus suitable for transmitting. This includes transmitting inductances, transmitting variable condensers and transmitting chokes. There is also a new type of anti-microphonic valve-

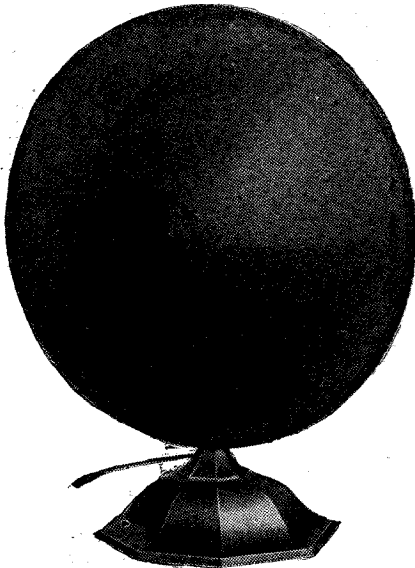

*The Western Electric Co., Ltd., have produced a new loud-speaker, the "Kone."*

holder, and other devices include a combined filament rheostat and grid-leak, and a representative exhibit of honeycomb duolateral inductance coils, intervalve transformers and filament rheostats, as well as the Igranic Electric soldering-iron.

A new fixed condenser is being shown by the Watmel Wireless Co., Ltd. (Stand No. 54). We understand that no wax whatsoever is used in the construction, the plates and mica being accurately assembled and clamped together in powerful presses, and enclosed in

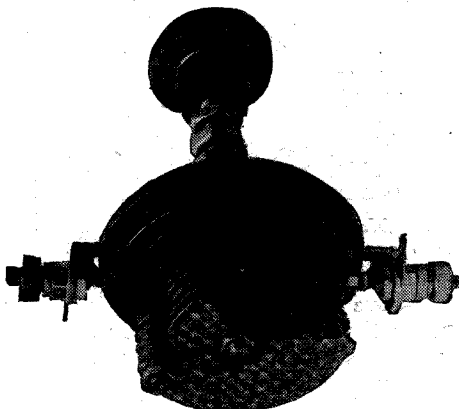

*The Igranic micro condenser (Igranic Electric Co., Ltd.).*

outer cases of bakelite or ebonite. Among other exhibits are displayed the Watmel variable grid-leak and

anode resistances, and the anodyne radio-frequency transformer.

Messrs. Bretwood, Ltd. (Stand No. 63), in addition to other exhibits, such as their well-known variable grid-leaks, are showing for the first time some new products, including an oscillator and a tunable transformer for super-heterodyne sets, and a variable low-loss condenser with or without reduction gearing.

The products exhibited by the Collinson Precision Screw Co., Ltd. (Stand No. 62), include the Colvern selector low-loss variable condenser. This instrument is so constructed that, in addition to the fine mechanical movement obtainable by the special drive, the scale value is directly relative to the fine control, so that one-twentieth of a degree is easily readable. The Colvern former for winding low-loss coils is also on view. This former consists

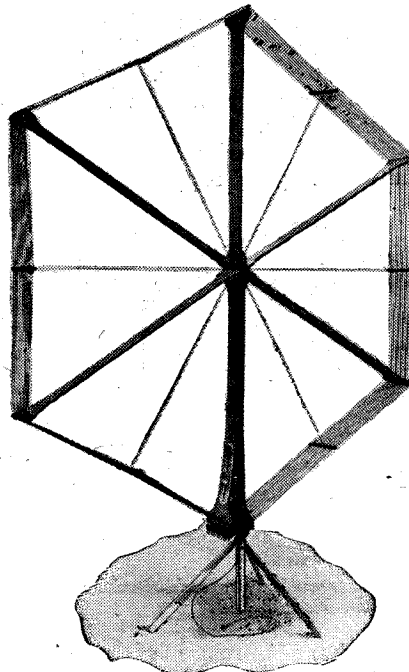

*A folding frame aerial shown by Portable Utilities Co., Ltd.*

of six ebonite tubes carrying a screw thread on the outside, and supported at each end by an ebonite ring.

A special self-supporting type of low-loss coil is shown by the Finston Manufacturing Co., Ltd. (Stand No. 61), together with other components. We understand that all moulded parts used on Finston components are made from a specially prepared compound, which possesses great dielectric and mechanical strength, and is non-hygroscopic.

In the "Receptor" low-loss inductance coil, shown by the Radio Reception Co. (Stand No. 56),

special attention is directed towards the airspaced windings and the insulation used, which is a composition of rubber-like material holding the windings firmly in position.

An interesting exhibit by Messrs. Pettigrew & Merriman, Ltd. (Stands Nos. 67 and 68), is the

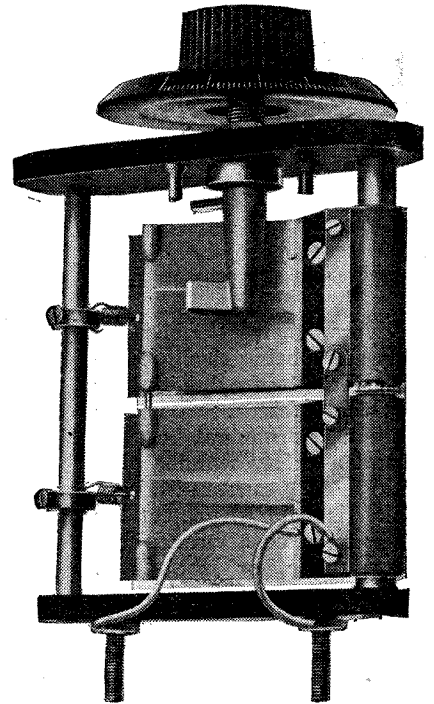

*A new design of variable condenser shown by Fellows Magneto Co., Ltd.*

Newey "4 point," low-loss, square-law condenser. Outstanding features of the design of this instrument are the square plates welded to the supporting pillar, and also to a bonding strip, and the employment of bakelite mouldings. Both sets of vanes move under a slow motion control, pigtail connections being provided. The Newey snap terminals and connectors are also to be seen. These are designed to provide easy and rapid connection of any number of pairs of 'phones to a receiving set, and also to allow



*A fixed condenser exhibited by Watmel Wireless, Ltd.*

for removal without interference or annoyance to other listeners.

The Portable Utilities Co., Ltd. (Stands Nos. 42 and 43), are showing a new series of "Eureka"

transformers, which are said to embody much heavier gauges of wire than have previously been practical in transformer design. In addition

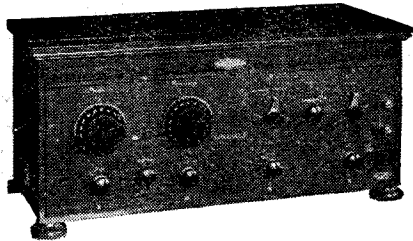

**A super-heterodyne receiver produced by Peter Curtis, Ltd.**

to the above, other lines displayed include L.F. choke units, potentiometers, frame aerials, and the Eureka rotary detector.

Two new products displayed by the Microhm Engineering Co. (Stand No. 57), are an L.F. transformer employing toroidal coils wound on a moulded former and enclosed by stalloy case plates, and a new high-tension battery in which the over-all dimensions and weight for a particular capacity are said to be considerably reduced.

The new Formo "Perfection" L.F. transformer, produced by the Formo Co. (Stand No. 71), is claimed to satisfy the needs of the most critical listener and lover of music. A 200-1 slow motion tuning dial is also manufactured, enabling delicate adjustments to be made.

Four types of valves are shown by Cleartron Radio, Ltd. (Stand



**Portable Utilities Co., Ltd., are exhibiting their Eureka Baby Grand low-frequency transformer.**

No. 44), together with a demonstration of the different stages in their manufacture.

Messrs. C. A. C., Ltd. (Stands Nos. 48 and 49), are also showing their bright- and dull-emitter valves.

This firm also gives prominence to the "Violina," a cabinet model loud-speaker, whose performance, we understand, leaves nothing to be desired in respect of quality of reproduction.

In the "Brandola" loud-speaker, exhibited by Messrs. Brandes, Ltd. (Stand No. 34), a large diaphragm is employed which is claimed to improve reproduction over the range of 200 to 4,000 cycles per second.

A series of rotary rectifiers in various sizes is being shown by W. Woods (Stand No. 64), and also D.C. motor converters for stepping down the voltage of the mains to a lower value for battery

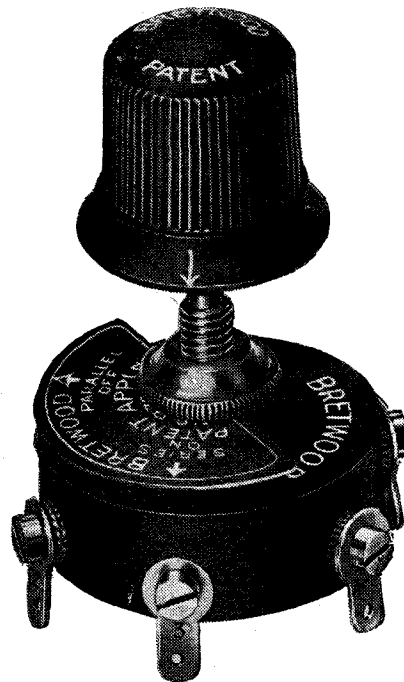

**A series-parallel switch exhibited by Bretwood, Ltd.**

charging. Messrs. Sparks Radio Supplies (Stand No. 55) are also exhibiting their "Radiohm" rectifier for the home charging of accumulators from A.C. mains.

All-British manufacture is a feature of the products of the Stella Works (Stand No. 8), L.F. transformers, variable condensers, headphones and loud-speakers being among the components shown.

On Stand 45 may be seen the whole of the comprehensive range of authoritative literature produced by Radio Press, Ltd.

No less than five periodicals are now published by this firm. *Modern Wireless* and *The Wireless Constructor* appear monthly, *Wireless Weekly* and *Wireless*—the "one-word" weekly — being weekly journals.

Very prominent in the display is to be seen *The Wireless Dealer*, the new monthly trade journal.

In addition to the above are



**Fellows Magneto Co., Ltd., are showing their Volutone loud-speaker.**

shown the series of Radio Press books, dealing with both the theoretical and practical sides of the subject, and the envelopes, panel cards, simplex radio charts and Radio Press panel transfers, all for the use of the constructor.

Radio Press, Ltd., meets the needs and requirements of all wireless amateurs and experimenters; whatever their skill or knowledge,

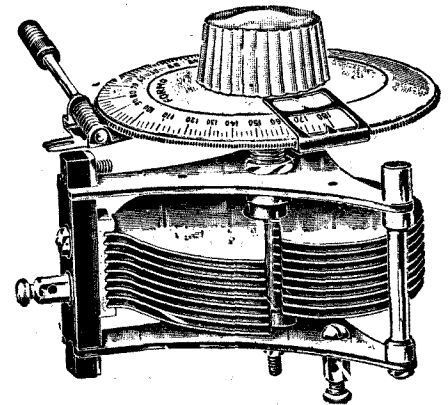

**The Formo variable condenser with worm gear incorporated for vernier control (The Formo Company).**

in these books they will find sound guidance, useful information and up-to-date reports of progress made in the science of radio-communication.

# Wireless News in Brief.



**Amateur's Success with Short Wavelengths.** Another wireless record has been set up by Mr. Gerald Marcuse (G2NM), of Caterham, in establishing two-way communication with a station at Kohat on the North-Western Frontier of India. The station in India was using continuous wave telegraphy, but Mr. Marcuse was transmitting speech and gramophone records. The operator of the station at Kohat states that he has been regularly receiving speech from Mr. Marcuse, and that he can receive his Morse signals at any time. This two-way communication was effected on a wavelength of 45 metres, Mr. Marcuse using Marconi Type T250 valves with 600 watts.

\* \* \*

**Wireless Control.** During recent exercises of the Mediterranean Fleet, a wireless controlled target ship, the *Agamemnon*, was employed. Without a man on board, the *Agamemnon* can manoeuvre, change course, increase or decrease speed, and send up a smoke screen.

\* \* \*

Experiments are being made by engineers of the British Broadcasting Company, in connection with a "Round the Continent" programme, which is shortly to be broadcast from 2LO. For an hour listeners will get the pick of the best Continental programmes.

\* \* \*

**Broadcasting in India.** We understand that in the Indian Parliament it was stated, in reply to a question, that the administration of broadcasting in India will be in the hands of the Post and Telegraph Department. The establishment of an advisory board was under consideration. Toll broad-

casting will not be allowed at the commencement of the broadcasting service. If a demand for it arises subsequently, the matter will receive attention.

\* \* \*

**Daventry Heard in India.** A reader of the *Times of India*, of Bombay, reported the reception of Daventry, the new 5XX, and said that the piano came through exceptionally well on the headphones and was just audible on the loud-speaker.

\* \* \*

**Wireless for Lightships.** Wireless installations have been fixed on several of the lightships marking the Goodwin Sands, and Trinity House proposes to deal similarly with other ships round the coast. The work will be proceeded with as funds and opportunity allow.

The primary object of the equipment is to maintain communication with shore stations, but as far as the exigencies of the service permit the apparatus will enable the crews to enjoy broadcast programmes.

\* \* \*

**B.B.C. Land Lines.** From the beginning of November all stations north of Leeds will be linked up by land-line to Leeds instead of to London, thus eliminating several hundred miles of land-lines hitherto used. Between London and Leeds four special lines have been set apart for the use of the B.B.C. The arrangements at Leeds to send out the programmes or items to northern stations will be much more automatic than they have been from London. Instead of the engineers in the London control room feeding other stations, the stations depending on Leeds will help themselves. The distant station will make its own connection with Leeds by the manipulation of

a single plug, which will also control the necessary amplifying apparatus.

The chief function of Leeds as a pivotal point will be to improve the quality of all items which it receives from London to the same excellence as when they left the Metropolis. Distortion and other faults will be corrected and weak signals amplified before they are passed on, so that listeners should get improved reception from many local stations, as well as a general speeding up in the S.B. part of the programme. The policy is to develop land-line communication to the highest efficiency, and, in the near future, another pivot, similar to that at Leeds, will be installed to facilitate simultaneous broadcast arrangements between London and the West Country.

\* \* \*

We are informed that entertainments from the saloons of two aeroplanes of the Imperial Airways, Limited, will be broadcast from 2LO on November 10, as the aeroplanes are flying over London.

\* \* \*

**Brazil: New Radio Station.** A wireless telegraph station, employing the Telefunken system, has been opened at Salinas, 70 miles east of Para, under the supervision of the Brazilian Telegraph Department.

\* \* \*

**Ships' Wireless.** By agreement between the British, Canadian, and United States Governments, merchant ships after October will cease operating their wireless apparatus on a wavelength of 300 to 450 metres when within 250 miles of the coasts of the three countries. The object is to prevent wireless broadcast programmes from being interfered with by Morse.



# Straight-Line Frequency Dials

By SYLVAN HARRIS

In previous issues of "Wireless Weekly" articles by Sylvan Harris have appeared on Straight-Line Frequency Condensers. In this article Mr. Harris describes in detail a further development in connection with these instruments.

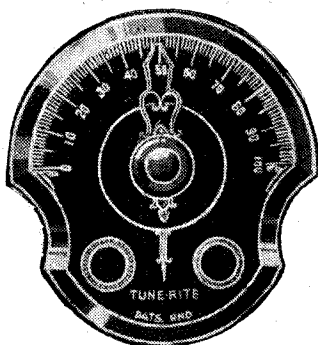
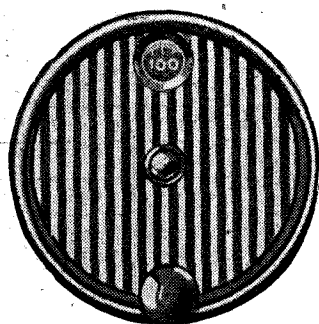

Two examples of straight-line frequency dials of the type described in the accompanying article.

motion to the condenser plates in accordance with the above law, as the motions in such apparatus involve both rotation and slipping, the combination of which makes the kinematical analysis difficult. Furthermore, the shape of the curve and the premises of the case depend upon the particular mechanical arrangement which is used, and obviously will be different for every individual case. There are a number of mechanical arrangements which may be used to obtain the motion required, a few of which are described in this article.



THIS season brings two great developments in wireless receiver design, not in the fundamentals, but in the technique. These two developments are in the tuned circuits of the receiver, and are a result of the desire of the users, and the ambitions of the designers, to produce receivers that are more convenient to operate and less difficult to adjust.

The first of these developments, as everyone knows by this time, is the straight-line frequency condenser. This condenser has been studied in detail in Vol. 6, No. 16, of *Wireless Weekly*, and in subsequent issues. It will not be necessary, therefore, to review here the desirability and convenience of the straight-line frequency characteristic, although it may pay the reader to re-read those articles and refresh his memory on the subject.

## New Developments

The next development -- the straight-line frequency dial -- is a result of recognition received by the straight-line frequency condenser, and the desire of the radio user to obtain the benefits of the straight-line frequency idea without going to the considerable expense of replacing the semi-circular condensers which he already had in his set, with the newer type. The straight-line frequency dials are designed to rotate the plates of the semi-circular condenser in such a way that a given speed of rotation for the dial moves the condenser more swiftly on one end and more slowly on the other, so that the S.L.F. characteristic is attained.

## Linear Calibration

In the previous articles I have written on the subject of straight-line frequency condensers, I have shown that, in order to obtain such a linear calibration, the capacity of the condenser must vary inversely as the square of the dial setting. In other words, if the capacity of the condenser at 100 on the dial is  $0.0005 \mu\text{F}$ , then at 10 on the dial the capacity of the condenser should be  $(10 \div 100)^2 \times 500$ , or  $5 \mu\text{F}$ . At this point it must be remembered that the dial should read 100 when the condenser plates are all the way out, and zero when they are all the way in mesh.

## Law of the Straight-Line Frequency Dial

This is the law of the straight-line frequency condenser, and the same law holds true for the straight-line frequency dial. For a semi-circular plate condenser, the capacity of the condenser is directly proportional to the angle through which the plates are turned.

Now, if the straight-line frequency law is to hold, it is necessary that the capacity  $C$  be inversely proportional to the square of the angle of the dial, which, combined with the above relation, requires that the angular setting of the plates be inversely proportional to the square of the dial setting. This, then, is the required law of the straight-line frequency dial. It will be noted that this is the same law as applies to the straight-line frequency condenser.

## Theoretical Design

It is a rather difficult matter to deduce mathematically the shape of a cam or groove which will furnish

## Types of Dials

There are two particular cases in connection with the dials which are being introduced which must be carefully distinguished from one another. The reason for this is that all of them, or nearly all, will probably be called "straight-line

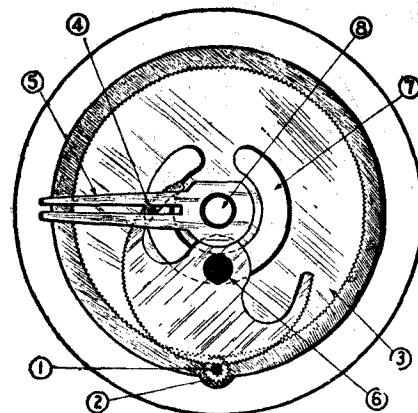

Fig. 1.—In this dial pinion 2 rotates plate 3, which carries the calibration scale. Pinion 1 moves the sector about the centre 6. Pin 4, fastened on sector, thus changes its radius in arm 5. The smaller the radius the faster arm 5 revolves about 8, which carries the condenser spindle.

frequency" or "S.L.F." dials. Some of the dials will be designed to furnish exactly linear calibrations (of course, forgetting the effect of circuit capacities for the moment), and others will be designed to fur-

nish only approximately linear calibrations. This will be brought out more thoroughly as we proceed.

**The Condenser Motion**

The particular motion which is given to the condenser plates as the dial is turned is as follows:—

Starting at a dial setting of 100, when the plates are entirely out of mesh, as the dial is slowly turned, say, from 100 to 90, the plates slowly move into mesh. As the dial is turned around further and further, all the time at the same rate, the condenser plates rotate into mesh at a greater and greater rate.

**Graphical Determination**

The motion of the plates with respect to the motion of the dial may be studied from the curves of Figs. 3 and 4. In Fig. 3 the axis at the bottom represents the setting of the plates of the condenser, that is, as if an ordinary dial were used. In other words, the bottom axis may be taken as representing the angle of motion of the condenser plates. The axis at the left (vertical) represents the capacity of

the condenser is called a straight-line capacity condenser. The curve BC, on the other hand, gives the values of capacity that are required to make the condenser give a straight-line (or linear) calibration of frequency against dial setting. This has been computed from the inverse square law, which applies to S.L.F. condensers. The first ten divisions on the dial have been neglected, since, if D is zero, C becomes infinite. This matter has been explained in detail in *Wireless Weekly*, Vol. 6, No. 16, in my first article on the straight-line condensers.

**Plotting Dial Settings**

It is easy to determine from these two curves the relation between the angular setting of the condenser plates and the dial reading of the S.L.F. dial. Simply follow the path indicated by the broken lines and the arrows. For instance, if  $D_p$ , the setting of the plates, is 20, the setting of the S.L.F. dial will have to be 57, as indicated on the horizontal axis at the top of the graph. If this procedure is followed out point for point, a curve, as

which are caused by the curved portions of the curve AB in Fig. 3.

**The Purpose of the S.L.F. Dial**

Before going into the various mechanisms that will give the required motion of the plates, it may

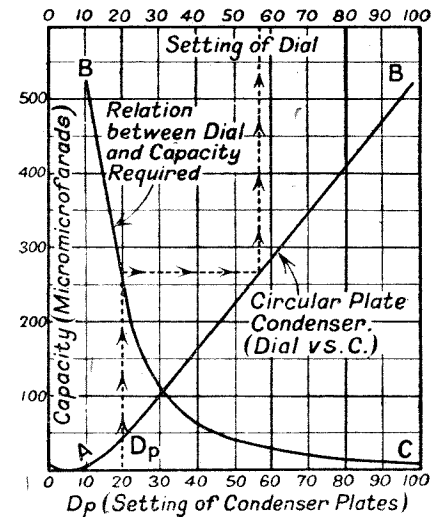

Fig. 3.—The curve shown in Fig. 4 is obtained from the capacity and frequency calibrations above by following the path of the dotted line.

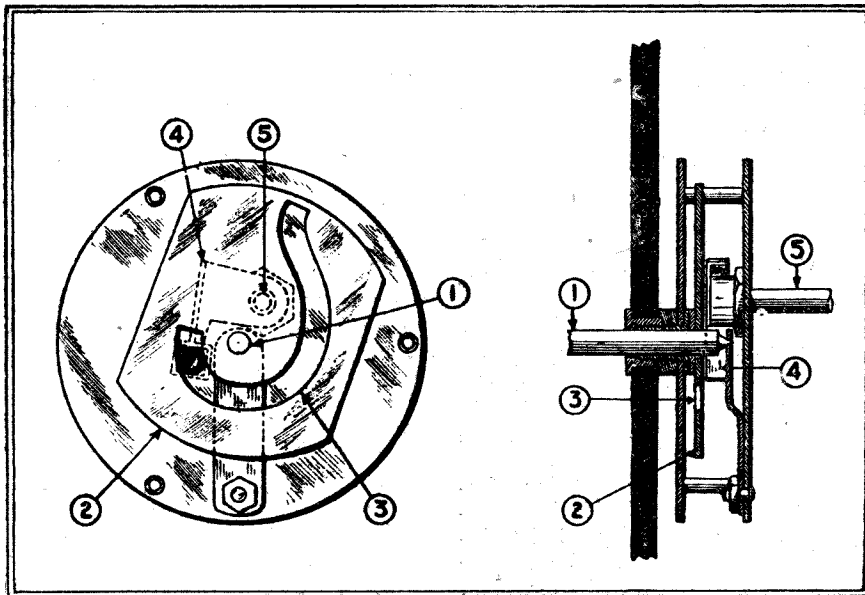

Fig. 2.—Another form of dial mechanism, in which shaft 5 turns plate 2, which carries a pin travelling in slot 3. This rotates arm 4 and condenser spindle 1. The distance between the centre 1 and the pin thus continually changes.

the condenser at any setting of the plates.

**Curve of S.L.F. Condenser**

On this graph the curve AB is the usual straight-line graph of capacity against the angular setting of the plates. Everyone is familiar with this curve; because it is linear;

shown in Fig. 4, will result. The horizontal axis gives the angular settings of the condenser plates, and the vertical axis gives the dial settings.

This curve is very close to the inverse square-law curve, which was deduced above. The only variations are near the ends of the curve,

be well to clear up a little misunderstanding that has come to my notice. A correspondent belittled the S.L.F. dial on the score that near one end of the motion the effect was merely the same as could be obtained with any so-called vernier dial, and for that reason he might just as well use the vernier dial. What he says is true as far as concerns the separating of stations on the dial, but the same thing is true of the S.L.F. condensers with the specially-shaped plates.

**Vernier Effect**

As the plates are turned out further and further, their area becomes smaller and smaller, and the effect is the same as could be obtained by using a so-called vernier condenser, that is, a small condenser of two or three plates. The reader must bear in mind that the S.L.F. condenser and the S.L.F. dial fulfil two requirements: they not only furnish a linear calibration between the frequency of the tuned circuit and the dial setting; but act as verniers at the same time. Furthermore, if there were no crowding of stations on certain parts of the dial there would hardly be any need for vernier adjustments.

**Mechanical Principle**

In the construction of the S.L.F. dial the mechanical principle em-

ployed is always that of the lever, as applied to a varying radius of the path of motion of a point fastened to the movable plates. For instance, imagine a plate which can be rotated about its centre. This plate has a groove in it, in which travels a pin at the end of an arm. The arm has likewise a slot in it, so that the pin can travel up and down the length of the arm.

**Cam Action**

As the plate is rotated, the pin moves outward from the centre. The greater the distance the pin is from the centre the faster will it move around the centre. The actual law of motion of the pin depends upon the shape of the groove, and can be made to vary within wide limits. The pin is fastened at the end of an arm, which rotates the condenser plates.

**Various Types**

Many variations of this principle are possible, as can be seen in the various illustrations on these pages. Sometimes ring-gears and pinions are used, but the design is greatly restricted by these, as the motions are, in turn, restricted by the possible ways of designing gears.

**Methods of Construction**

Other ways of constructing variable motion dials employ gears of special design, such as elliptical or hyperbolic shapes. The use of such

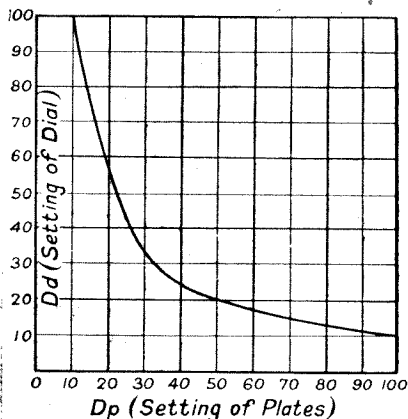

Fig. 4.—The angular setting of the condenser plates varies with the angle of the dial in accordance with the curve shown.

elliptical gears is, however, not altogether satisfactory, since this type of gear does not allow linear calibration, but only an approximation to the linear. Hyperbolic gears are difficult to use, because of their tendency to jam, and because they require a lot of room

in which to operate. They have not been used as yet in a commercial product.

**Advantages of S.L.F. Dials**

The fact that only an approximation to the linear can be obtained in calibration with one of these dials should not deter the radio enthusiast from using them. The principal reason why these dials are manufactured is not necessarily to furnish linear calibration but to enable us to avoid crowding of stations on the dial. However, if the calibration can be made linear at the same time that the stations are separated, so much the better.

**Minimum Capacity**

Before closing this article we

must not forget the necessity of having the proper minimum capacity in the condenser. The dial should be constructed (if linear calibration is desired) so that the plates of the condenser are partly in mesh when the dial reads 100, so as to furnish the proper minimum capacity. Or, if not designed to take care of the minimum, a small variable condenser should be shunted across the main condenser, adjusted to the proper value, and let alone. If the minimum capacity is not of the proper value, the calibration curve will depart from the linear. This, however, will not interfere materially with our ability to separate the stations when tuning.

**OBITUARY**

WE regret to announce that Captain M. H. P. Riall Sankey, C.B., C.B.E., R.E. (retired), died suddenly of heart failure on Saturday, at his



Captain M. H. P. Riall Sankey.

residence at Ealing, at the age of 71. Born at Nenagh, Ireland, on November 9, 1853, the son of General W. Sankey, C.B., he was educated in Switzerland and at Mr. Rippin's school at Woolwich, passing in due course through the Royal Military Academy and obtaining his commission in the Royal Engineers in 1873. He also passed through the School of Military Engineering at Chatham. In 1876 he entered the "Barracks

Branch" of the War Office, and was engaged in architectural design, but shortly afterwards was placed in charge of the Royal Engineers' Drawing Office at Manchester. In 1878 he was ordered to Gibraltar in charge of the Military Telegraphs and Signal Station. The next year he was appointed Instructor in Fortification at the Royal Military College, Kingston, in Canada. Three years later he was placed in charge of the Trigonometrical Division of the Ordnance Survey at Southampton, where he made various improvements in the system of lithographic and copperplate printing. He was the first to apply dynamos to the process of copperplate reproduction for map printing.

In 1889 Captain Sankey retired from the Army and joined the board of Messrs. Willans and Robinson, Ltd. Later, he took an important part in designing the Victoria Works, Rugby, and he was designer of the steam turbines which were afterwards manufactured by the firm.

In 1905 Captain Sankey severed his connection with Messrs. Willans and Robinson to take up work as a consulting engineer, and some years later became director and consulting engineer of Marconi's Wireless Telegraph Company, Limited, the Marconi International Marine Communication Company, Limited, and other companies.

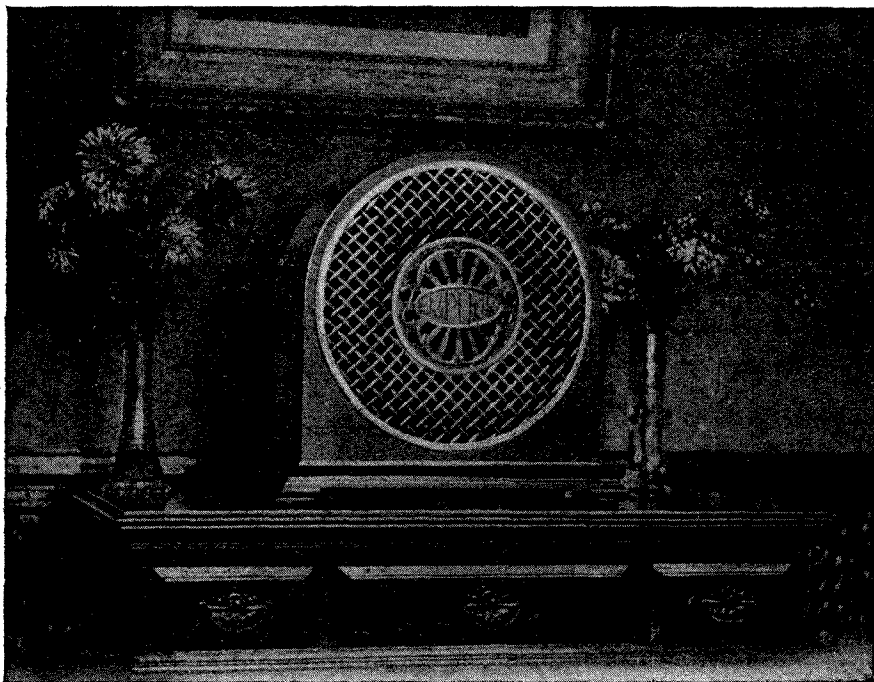

Model RS1.M., with mahogany cabinet and oxydised silver "grille." Price 8 gns.

## A Revelation in Radio Reproduction

THIS new RADIOLUX AMPLION Loud-Speaker represents an outstanding triumph in the art of Loud-Speaker design, being totally different in appearance, in construction, and in results.

Louder, clearer, more sensitive and realistic in tone than any contemporary instrument, the RADIOLUX AMPLION is a revelation in every essential loud-speaker quality.

Not only is the spoken word and the song of the vocalist true to life, but instrumental music is almost indistinguishable from the original studio performance. Outwardly resembling the English bracket clock—in itself a standard to the world—the cabinets possess that beauty of form and superlative finish which denote the masterpiece.

The RADIOLUX AMPLION is also available in a smaller size and in metal, oak and de-luxe finish at prices from £4.15.0

Patentees and Manufacturers:

**ALFRED GRAHAM & CO. (E. A. GRAHAM),**  
St. Andrew's Works, Crofton Park, London, S.E.4.

# Radiolux AMPLION

Demonstrations gladly given during business hours at 25, Savile Row, London, W.1; 79, High Street, Clapham, S.W.4; and at the newly opened Scottish Depot: 101, St. Vincent Street, Glasgow.

FOR · THE · FIRST · TIME · IN · LOUD · SPEAKER · HISTORY  
SCIENCE · AND · ART · GO · HAND · IN · HAND.

### Wireless Weekly Small Advertisements.

**A TECHNICAL ASSISTANT** is required at the Royal Aircraft Establishment for writing technical descriptive matter and instructional handbooks on wireless apparatus. Applicants must have a sound technical knowledge and a capacity for clear expression in good English. Some experience in writing for publication is desirable. Ex-service man preferred. Salary £250 rising by annual increments to £350, plus Civil Service bonus, giving total starting remuneration of £369 per annum. Applications should be made on forms to be obtained from the Superintendent, R.A.E., South Farnborough, Hants, quoting A.85.

**ENGRAVING** ebonite panels by machine. Low price for quantities. Single panels engraved. Express Delivery.—Endacott's, Ltd., 58g, Hatton Garden, E.C. 'Phone: Holborn 1809.

**TELEPHONE RECEIVERS** and Loud Speakers Rewound, 2,000 ohms, 3/6.—A. Roberts & Co., 42, Bedford Hill, Balham, S.W.12.

**A REMARKABLE Opportunity.** For Sale:—Two complete sets of receiving and transmitting (30 watt) C.W. and telephonic apparatus, including masts, aeriols, amplifiers, Brown loud speaker, telephones, batteries, valves, etc., packed in 11 strong cases for travelling, in working order. Cost over £200. Some of it has been, and the rest can easily be, adapted for use for broadcast reception. Offers invited. A complete list can be obtained from Adjutant, 96th (Royal Devon Yeomanry) Field Brigade, R.A., 9, Dix's Field, Exeter. Much of the apparatus being exceptionally well made, is well worth purchasing by an experimenter for the parts contained.

**2-VALVE Amplifier, 35/-**, use one or two valves; also 1-Valve Amplifier, 20/-, both perfect, as new. Valves, 4/6 each. Smart Headphones, 8/6 pair. New 4-volt Accumulator, celluloid case, 13/- . New Dura 66-volt H.T. Battery, guaranteed, 7/- . 2-Valve All-Station Set, works speaker, £4. Approval willingly.—W. TAYLOR, 57, Studley Road, Stockwell, London.

**HEADPHONE REPAIRS.**—Re-wound, re-magnetised, readjusted. Lowest prices quoted on receipt of telephones. Delivery three days. Est. 26 years.—Varley Magnet Co., London, S.E.18.



Established  
26 Years.

## REPAIRS

TO HEADPHONES  
TO LOUD SPEAKERS  
TO COILS

Re-wound to any Resistance and made equal to new. Price quoted on receipt of instruments.

Prompt Delivery.

**The VARLEY MAGNET  
Company** WOOLWICH, S.E.18.

'Phone: Woolwich 888.

**'PHONES REMAGNETIZED FREE**  
ALL MAKES REWOUND, 4,000 ohms, 5/-  
'Phones Rewound are Remagnetized Free.  
Remagnetizing only 2/- . Loud Speakers from 3/6.  
Transformers from 5/- . Post extra.  
The H.E.F. Co., 46, St. Mary's Road, Leyton, E.10

**Splendid  
BIRTHDAY  
Number**

**THE WIRELESS CONSTRUCTOR**  
124 pages (Free Blue Print).

Price 6d. as usual. On Sale To-morrow.



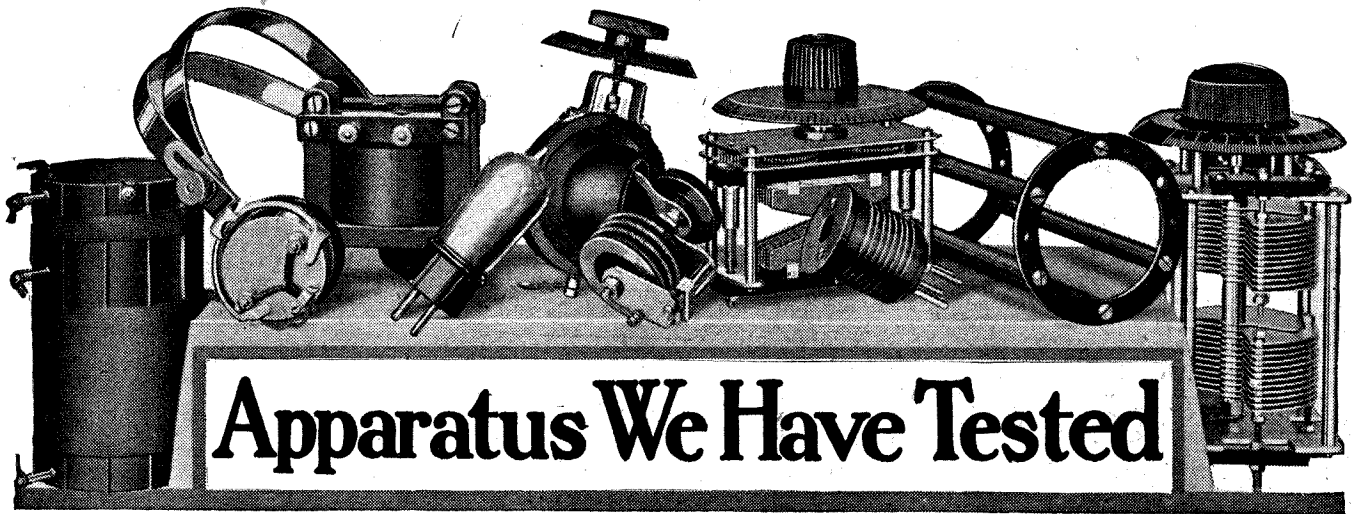

## Apparatus We Have Tested

Conducted by A. D. COWPER, M.Sc., Staff Editor.

### Combined Valve-Holder and Rheostat

A combined valve-holder and filament rheostat of particularly neat design is that sent for our comment by Messrs. the London & Provincial Radio Co., Ltd. This resembles in some particulars a type of filament rheostat already commented upon in these columns, but has on the top of the frame (which is mounted by the same type of one-hole-fixing device) a low capacity type of valve-holder, with externally insulated valve-leg sockets, the anode socket being distinguished by being of a red colour. The contact fingers or brushes in this new type are long springs of phosphor-bronze, and were found to make good contact with the sliding resistance solenoid. Control by a small knob and sliding spindle is provided, similar to that in the older pattern. The high-resistance D.E. and the .75 ampere type of resistor are interchangeable, a matter of some convenience when changing over valves. The valve-holder part can be removed at will by withdrawing two small screws. Terminals are provided on the rheostat portion, and soldering tags for the remaining connections.

Practical trial showed that care had to be taken when soldering connections to these tags to avoid softening the ebonite holder-base and so loosening the sockets. The unit was found to be easy to mount, and to give a neat and compact instrument when arranged according to the popular vertical panel and base-board style of receiver, the wiring being appreciably simplified. The same smooth and convenient control of filament temperature as noticed in connection with the earlier pattern was obtained on trial, and the resistors proved of suitable value for their purpose.

### Panel Selector Switch

A particularly neat type of multi-point selector-switch for mounting on the panel front is that submitted by Messrs. Burne-Jones & Co., Ltd. The sample, which was a 10-way switch with two extra stop points, occupied

a circle of  $1\frac{1}{2}$ -in. diameter only, when duly mounted on a small panel. A centre screw-bush is provided, which proved to be easy to apply, and the switch arm was free from shake and operated smoothly. The stop points were favourably commented on, and appeared neater and more stable than the customary small stop-pins. Finish and workmanship were of a high order.

### Insulated Wires and Cables

From Messrs. Ripaults, Ltd., have arrived a number of samples of insulated wires and cables particularly suited for radio purposes. These appear to be of high quality, the appearance of the silk-covered twin flex (for battery and long phone leads, etc.) being particularly pleasing. The twin flex samples were of the 14/36 type, and in various colours; single insulated wire with rubber insulation, suitable for low-frequency circuits in a receiver, was shown in Nos. 16, 18 and 20; ordinary cable suitable for earth-leads and aerial lead-in, with thin rubber insulation, in 2 and 3 millimetre sizes, and a specially high-class and heavily insulated cable with three-ply covering of 4, 5 and 7 millimetre size. The latter would be suitable for specially heavy service, and was of the most substantial build. It is evident that Messrs. Ripaults, Ltd., have effectively met a demand for high-class radio cables with the types submitted for our inspection.

### Gecophone Geared Condenser

Messrs. the General Electric Co., Ltd., have submitted a sample, of nominal .0005  $\mu$ F capacity, of their new friction-gear variable condenser, of square-law type. This is of the single-hole-fixing variety, and the fine adjustment feature is carried out by a train of friction wheels, a small bevel-edged wheel engaging between the edges of the spring discs of a larger double wheel at each of two stages of gearing, giving a peculiarly smooth motion and freedom from back-lash.

The fixing device has a range to accommodate panels from  $\frac{1}{4}$  in. to  $\frac{3}{8}$  in. thick; it is decidedly complex in operation, and great care should be taken by the amateur constructor in dismantling this part for mounting the instrument.

It was further noticed, on practical test, that it was not difficult to twist the mounting bush in the frame, so that further means of fastening the condenser were required if calibrations were to be retained. A heavy brass frame is provided in the instrument, and the fixed plate assembly is mounted in this by very small insulating bushes, with a screw adjustment which appears to be called for by the very narrow spacing of the plates, the .0005  $\mu$ F size being unusually compact. The insulating resistance, under normal conditions, appeared satisfactory, in spite of these tiny bushes; on testing the H.F. resistance under operating conditions, the condenser appeared to be of favourable character in this respect, though a little short of a standard pattern with ample ebonite insulation in the form of wide end-plates. No terminals are provided, but small soldering tags are supplied. The maximum capacity was around .00054  $\mu$ F, the minimum being the satisfactorily low figure of  $9\frac{1}{2}$   $\mu$ F.

The gearing ratio appeared to be about 13 to 1, sufficiently fine for separating stations below 1,000 kc. frequency, but hardly giving fine enough adjustment, in this size, for close work between 1,500 and 1,000 kc. in conjunction with a suitable inductance, the stations being very crowded here. The fine, smooth action of the friction gear and the decreased hand-capacity effects as a result of the large knob fitted, and of the grounding of the rotor and frame made possible in this instrument, were conspicuous in an extended test around the stations. The smaller sizes in particular should be very useful in fine work in the latter two-thirds of their scale.



# CORRESPONDENCE

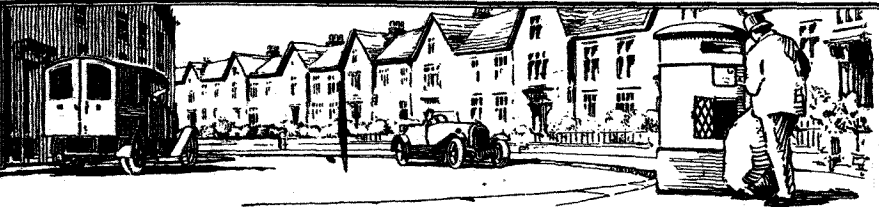

## AERIALS AND LIGHTNING

From Prof. C. L. Fortescue, M.A., M.I.E.E., Advisory Editor to Radio Press, Ltd.

SIR,—A few instances have been reported during the past summer of wireless apparatus being destroyed by lightning, but considering the number of aerials now in use the damage has been unexpectedly small. The extent to which aerials are affected by lightning discharge and the results likely to arise therefrom are questions of practical importance to all users of wireless apparatus, and an attempt is being made to collect information relative to actual cases in which aerials and apparatus have suffered in this way. I should be glad if I may use the publicity of your columns to ask anyone, and everyone, whose apparatus has been damaged to forward full information to me at the address given below. The data particularly required are:—

- The date and time of the occurrence.
- The position and approximate dimensions of the aerial.
- The nature and position of the earth connection.
- A brief description of surroundings, *i.e.*, position of adjacent houses, trees, telephone wires, etc.
- Whether the aerial was directly earthed or whether either receiving or transmitting apparatus was in circuit.
- The fullest possible description of the incident and the nature of the damage done.—Yours faithfully,

Cecil L. Fortescue.

City and Guilds (Engineering) College, Exhibition Road, S.W.7.

## "A NEW LOUD-SPEAKER CIRCUIT"

SIR,—Re *Wireless Weekly*, issue September 16, "A New Loud-Speaker Circuit," I am happy to inform you that, unlike many freak circuits which I have set up, my efforts with the above have not been wasted.

The circuit, as Fig. 1 in the article quoted, is most satisfactory, giving powerful loud-speaking on 2ZY, which is some five miles away. Not only is it loud, but its purity is, as stated, superior to a crystal and L.F. amplifier; in fact, for anyone content with quality on their home station I know of nothing to equal it, and my experience is not small, as I have made up all sorts of circuits from crystals to 10 valves, but the best resistance-coupled

set with wire wound resistances and expensive mica coupling condensers in no way approaches your design for purity and volume. Perhaps the following details may interest you:—

V<sub>1</sub>, a D.E.5.B.; battery B, 12 volts; resistance R, 80,000 ohms; V<sub>2</sub>, a B<sub>4</sub> with 60 volts H.T. through primary of transformer; V<sub>3</sub>, a D.E.5.A. 120 volts H.T., with 12 volts negative bias; transformer, ratio 6/1, 2  $\mu$ F Mansbridge condensers between L.T. negative and each H.T. tapping. A.T.I. composed of 60 turns No. 16 s.w.g. d.c.c. 3in. dia. self-supporting, "higgledy piggledy," with tap 10 from E end, Lissen X fashion. Capacity earth, consisting of length Electron buried under aerial 6 in. in ground. Aerial 7/22, 40 ft. high, 60 ft. long.—Yours faithfully,

H. S. Coppock.

Didsbury.

## THE "OMNI" RECEIVER

SIR,—About three months ago I purchased Radio Press Envelope No. 5, the Omni Receiver, and completed same. I am very pleased with results obtained, having had every station in the British Isles during the experimenters' half-hour on Monday even-

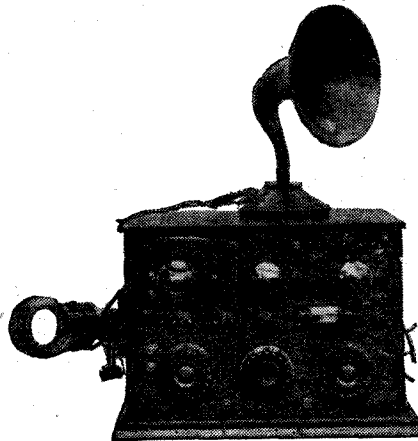

Mr. Clark's Omni receiver as described in Radio Press Envelope No. 5.

ings and at least eight Continental stations up to the present. The only alterations in the set are a .001  $\mu$ F variable condenser instead of .0005  $\mu$ F for aerial tuning.

I have found Fig. 15 in the instructions an excellent circuit for loud-speaker work, reception being very clear with grid bias. I am using three valves at present. I am now making a wave-trap from instructions in *The*

*Wireless Constructor* to use with the set.—Yours faithfully,

S. E. CLARK.

Bow, E.3.

## "A CHOKE-COUPLED 3-VALVE" RECEIVER

SIR,—In your "Unit Choke Amplifier" in *The Wireless Constructor* for April you invite those who make one of these units to write and tell you what they think of it. Though you did not give the same invitation regarding your "Choke-Coupled Three-Valve Receiver" in *Wireless Weekly*, date May 27, 1925, you may care to hear my experience with this set.

Early in June, having decided to acquire a wireless set and having been told that reception of stations north of Worthing was poor owing to screening by the Downs, I took 2s. 6d. worth of advice from the Radio Press, Ltd. I stated that I wanted the purest reception possible from the nearest station and that I had no particular wish for long range. I added that I had thought either of getting the "Choke-Coupled Three-Valve Receiver" made up for me or of buying some standard set, and asked that one likely to suit my requirements might be named. In reply I was told that if I intended to use a loud-speaker I had better get the "Family Four-Valve" Receiver described in one of the Radio Press Envelopes, but that for 'phones the three-valve set would be quite suitable, particularly as it was simple for a beginner to work. Your insistence on the exceptional purity of reproduction of the three-valve set, however, carried the day, and I had one made up for me. The valves I am using are R.5.V., D.E.5.B. and D.E.5. Daventry *without* reaction has to be detuned somewhat. Bournemouth and London are also regularly received with good volume on the loud-speaker, but a fair amount of reaction is required. A local "radio engineer" tells me that the quality is better than any he has heard, and that he would like to know how much of this is due to the set and how much to the loud-speaker. Probably it is a case of fifty fifty!

I do not often attempt to receive other stations than the three named, but have had many Continental stations on the 'phones, though no others of the B.B.C. Recently Radio-Paris was received quite satisfactorily on the loud-speaker.

The components are those specified by you. The only difference from the set as illustrated is that the wiring has been made more rectangular.—Yours faithfully,

W. B. RICHARDS.

Worthing.

**A "POWERFUL 3-VALVE" SET**

SIR,—After having built a few of your sets from *The Wireless Constructor* I have built "A Powerful Three-Valve Set," described in the April issue, by Percy W. Harris, M.I.R.E. I have given it a good test for about a month, and I am more than delighted with the results. I am sure it is the set many of us have been waiting for. I am using a B.T.H. B4 valve in the first L.F. stage, and a B.T.H. B7 in the second, and using a grid-bias on each valve of about three volts; music and speech come through very sweet and clear. I found the loud-speaker was much better with a .002  $\mu$ F condenser across the terminals.

I have no difficulty in picking up Manchester, although Leeds is only seven miles away, and Daventry is almost too loud even when reaction is uncoupled. Bournemouth comes in at good loud-speaker strength. I think this is one of the best three-valvers you have published, and if more generally used it would reduce the number of oscillators who try to get three-valve results out of two.—Yours faithfully,

ARTHUR DALEY.

Birstall.

**SHORT WAVE TRANSMISSION**

SIR,—We would be obliged if you will publish the present schedule of our telephony tests.

We will call: "Here Radiogiornale I.R.G."

We send every Sunday exactly at 15.00 G.M.T. on 18 metres and at 06.00 G.M.T. on 38 metres. Input 150 watts in each case.—Yours faithfully,  
ERNESTO MONTÙ (Operator), I.R.G.  
Bellagio Lake, Como, Italy.

**CORROSION OF EARTH LEAD**

SIR,—Here is something to warn your readers of. Last year I made an "earth" by burying a lead plate 3ft. down, plus the usual layer of coke, etc. To enable the earth to be kept damp a galvanised iron pipe was put down to the plate and so that its end was a few inches above ground and water could be poured right down to the plate. The earth wire was 7/22 enamelled copper stranded wire. This wire ran down to the plate alongside the galvanised iron pipe for some way. Using a powerful supersonic heterodyne set, reception on distant stations fell off unaccountably, but was cured by transferring the earth lead to a nearby radiator. Investigation of the lead plate earth showed that electrolytic action had taken place between the 7/22 copper wire and the galvanised iron pipe. The wire wherever it touched the pipe had become friable and brittle and some of the strands had

completely disappeared. The result appears to be similar to that sometimes experienced on board ship between the ship's plates and the copper or bronze of the propeller.—Yours faithfully,

C. R. BATES.

Market Harborough.

**ENVELOPE No. 4**

SIR,—My set is Mr. Harris' three-valve "All-Concert" circuit (Radio Press Envelope No. 4), but with an extra valve added with resistance coupling, separate H.T. + connections to each valve, power valves in both L.F. stages, with grid-bias to both. All Ediswan valves, lit by a 2-volt accumulator, and following H.T.: H.F. 60v., Detector 36v., first L.F. 80v., second L.F. 120v.

Quite accidentally I made a discovery a few days ago which may be of interest to readers of *Wireless Weekly*. I found that an ordinary wrought-iron standard lamp provided an efficient aerial for 5XX. It was necessary to alter tuning on the aerial condenser slightly, but when properly tuned the result was surprising. The volume was quite equal to that obtained from the outdoor aerial. The latter, however, was far more efficient for the reception of broadcasting on the shorter wavelengths.

The standard lamp aerial works two loud-speakers in parallel with extraordinary volume.—Yours faithfully,

S. A. BLACKALL.

Neath, South Wales.



**"TELWAVE"**  
(Registered)  
**RADIO COMPONENTS**  
(MARTIN - COPELAND PRODUCTS)



"Telwave" Switch-Plug and Jack.

**The "Rolls Royce" of the Radio World.**

*Our New Illustrated Catalogue will interest you.*

**TRADE ONLY SUPPLIED.**

**THE ELECTRICAL EQUIPMENT & CARBON CO., Ltd.,**  
109/111, New Oxford St., London, W.C.1

**"Use a 'U.S.' transformer—"**

Do your set justice by fitting a U.S. Super Transformer. For clear and distortionless amplification, it is the equal of the finest and most expensive transformer on the market.

|                       |                        |        |
|-----------------------|------------------------|--------|
| Made in<br>two models | Ratio 5:1<br>Ratio 3:1 | } 18/6 |
|-----------------------|------------------------|--------|

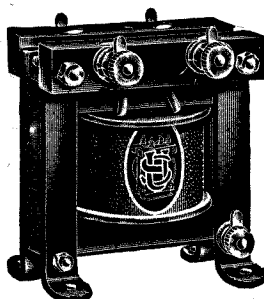

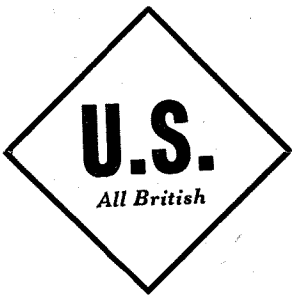

18/6

Trade Enquiries to  
**U.S. Radio Co., Ltd.**  
Dept. 14, Radio Works,  
Tyrwhitt Road,  
Brockley, S.E.4

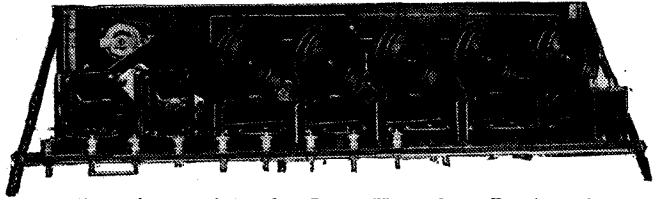

View of rear of 6-valve Super-Heterodyne Receiver, incorporating the essential whits and parts contained in the IGRANIC Outfit.

**A  
message  
to  
Super-Het.  
Constructors**

See the greatest advance in Supersonic-Heterodyne design yet made—on

**STANDS  
30 & 33**

at the  
**Wireless Exhibition  
and Radio Convention,  
Royal Horticultural Hall,  
Westminster, S.W.1.**

Here you will see THE ALL-IGRANIC RECEIVER EMBODYING the

**Igranic Supersonic-Heterodyne Outfit.**

It contains novel reactance capacity coupling units obviating the deliberate introduction of losses as a means of suppressing undesirable oscillation, such as by potentiometer control, and any tendency of the intermediate frequency amplifier to oscillate is cut off at its source.

The special method of securing stability employed in the self-stabilised reactance units enables a far higher degree of amplification to be obtained than would otherwise be possible.

Oscillator Units can be obtained in three sizes giving wave-length ranges of from 215 to 4,500 metres.

If you cannot visit the Exhibition send for the IGRANIC Instructional Envelope.

The IGRANIC INSTRUCTIONAL ENVELOPE for constructing a Six-valve Super-Heterodyne Receiver according to the Igranic system, complete with full-sized general arrangement drawing, wiring and drilling diagrams, and fully illustrated descriptive booklet can also be obtained from your dealer. Price 2/6.



**149, Queen Victoria St., London  
Works: - - - - BEDFORD**

**ELECTRADIX RADIOS**

**YOU** would not use an axe to wind a watch nor a pocket compass and a school atlas to pilot a ship in strange waters. A pocket voltmeter is equally inadequate for Radio Research experiments.



**CRYSTAL SETS.  
Mark III Tuners.**

You want an "ELECTRADIX GALVO," the bargain of 1925.

The new July edition of our famous **Catalogue of Radio Bargains** now contains 500 Illustrations of electrical instruments, radio sets and components of great interest. Many of these are unobtainable elsewhere and our prices are the very lowest.

The experimenter on short waves, the expert transmitter, or the crystal novice will all find it advantageous to have a copy of

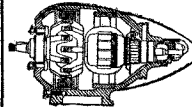

**200 WATT, 500  
CYCLE  
ALTERNATOR  
and EXCITER.**



**MIDGET M.C.  
0.10 m/a. 22/6**



**MIDGET M.C.  
CELL TESTER,  
2 range.**

**"THE CATALOGUE  
THAT SAVES  
YOU POUNDS"**

Its scope ranges from a 5/- pair of British Headphones or a 12/6 Milliammeter to a 30,000 volt Generator and covers all requirements.

If you cannot call and inspect goods in our show-rooms between 9 a.m. and 6 p.m., it will pay you to send 4d. for our Catalogue at once. Goods promptly despatched all over the world.

Colonial Avenue is the first on left down the Minorities from Fenchurch St., or Aldgate Underground Station.



**TESTING  
SILVERTOWN  
GALVOS.**



**EDISWAN  
VALVES,  
R.A.F. "C" Type.**



**H.T. VOLT  
METERS,  
G.E.C., 2-range  
1,000 and 2,000  
volts.**



**DISTANT  
SWITCHES.**

If you want to see the very latest components for all circuits you will find all the new



on the same stands at the

**Royal  
Horticultural Hall  
Westminster, S.W.1  
5 minutes from Big Ben**

**Oct. 10 to 16**

Write for the new Igranic List Y73 if you cannot visit the Exhibition



**LESLIE DIXON & CO.  
9, COLONIAL AVENUE, MINORIES, E.1  
and 218, UPPER THAMES STREET, E.C.4.**



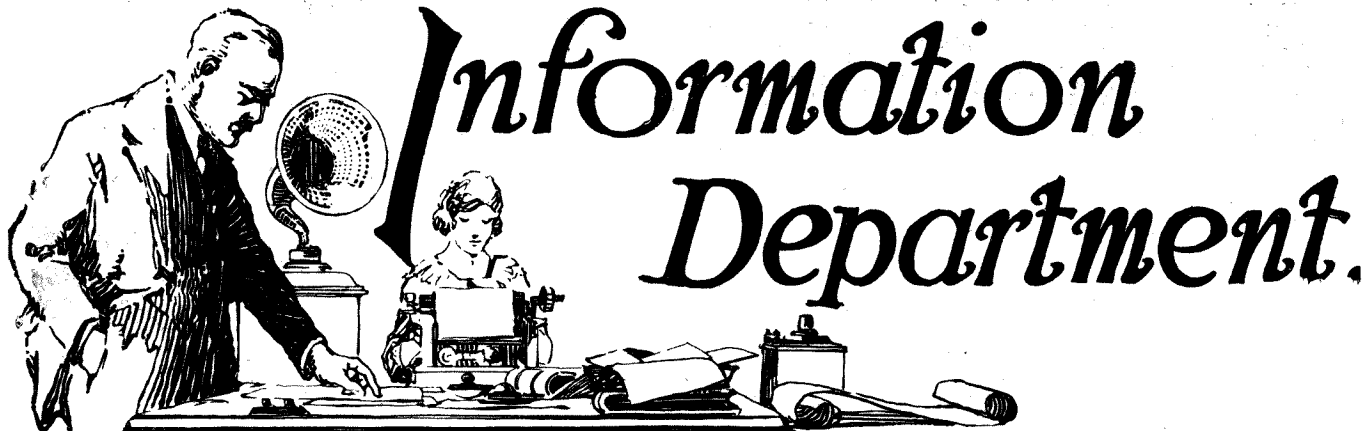

# Information Department.

F. C. (FRANT) has constructed the Transformer Coupled 3-Valve Receiver described by Mr. Rattee in "Wireless Weekly," Vol. 5, No. 4. He states that results are extremely disappointing, signal strength being only approximately half that which he can obtain with a detector and one low-frequency amplifier on the same aerial and earth system. He asks us what is wrong.

Examination of our correspondent's letter shows him to be a victim of the lack of standardisation in H.F. transformer connections. He is employing a mushroom type, in which the primary and secondary windings are wound in one slot. In Mr. Rattee's set the wiring is suitable for one

type of H.F. transformer, but not for the kind employed by our correspondent. The effect of reversing the leads to the secondary winding should be tried, when we think the set will be found to function in a satisfactory manner. If in any doubt as to the correct connections for a mushroom type of H.F. transformer such as that employed by our correspondent, we would advise him to refer to *Wireless Weekly* for September 17, 1924, in which a design is given incorporating a mushroom type H.F. transformer.

J. O. C. (BELFAST) states that he obtains excellent signal strength on telephones employing the first three valves of his Transatlantic 5-valve Receiver, but that the reception on

the loud-speaker is poor and spasmodic. He also asks us how to introduce a switch to cut the two high-frequency valves out of circuit when listening to his local station.

The spasmodic reception of which our correspondent complains appears to be such that good volume is obtained on the loud-speaker when the set is first switched on, but signals fade rapidly until almost inaudible, and then again increase in volume, after a short while. We would advise our correspondent to pay attention to the two grid-leaks R8 and R9; that is, the two associated with the two resistance capacity coupled amplifying valves. Should these components develop high resistances, the grids of the amplifying

## Only 7/- Each and Guaranteed for Twelve Months

So carefully are Bowyer-Lowe H.F. Transformers matched and tested at our works that you may buy any two at random and use them with perfect confidence for two stages of H.F. Amplification.

So well are these Transformers made that every one you buy is guaranteed up to the hilt for twelve months after purchase. If it fails it will be exchanged without charge.

In spite of their superiority these Transformers cost less than most. Ranges are made covering all wavelengths from 150 to 2,000 metres and up, as well as a special Neutrodyne Unit. All are sold at a uniform price of 7/-

Ask for them by name and see that you get them.

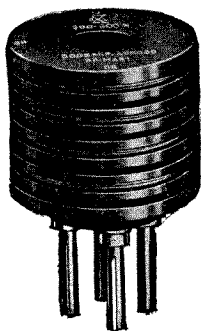

## Bowyer-Lowe Matched H.F. TRANSFORMERS

Good dealers stock them, or you may order direct.  
BOWYER-LOWE CO. LTD., LETCHWORTH.

FLETCHER.

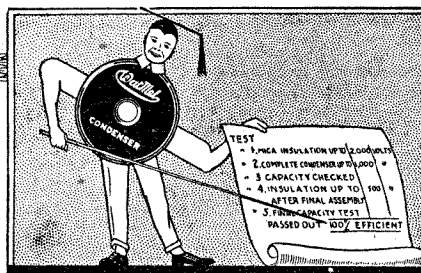

Sir, you've been looking for me!

RIGHT along you've wished for a better fixed condenser, and now, at last, such an instrument is obtainable. The *Efficient Watmel* is my name—a better fixed condenser, superior in all the points that make for highest efficiency. Witness my Test Report, it speaks for itself. Next time you're at your dealers, ask to see me. Close examination will decide you that I'm the fixed condenser you've been looking for.

### Watmel Test Report.

1. Mica Insulation up to 2,000 volts
2. Complete Condenser up to 1,000 volts.
3. Capacity checked.
4. Insulation up to 500 volts after Final Assembly.
5. Final Capacity Test. PASSED OUT 100% EFFICIENT.

### Prices.

Capacities for Standard Grid Condensers.  
 .00005 to .0005 - 2/6 each.  
 Standard Fixed Condensers.  
 .002, .001 - 2/6 each.  
 .0025, .006 - 3/6 each.  
 Combined Grid Leak and Condenser - - - 3/- each.

The Watmel Wireless Co., Ltd.  
332a, GOSWELL ROAD - LONDON, E.C.1.



Representative for Lancashire and Cheshire—  
Mr. J. B. LEVEE, 23, Hartley Street, Levenshulme, MANCHESTER.

Barclays  
Ad.

valves would become choked and account for spasmodic reception on the loud-speaker. We would suggest that both grid-leaks be changed for ones of low value, such as .5 to 1 megohm, or even if necessary down to .25 megohm for the latter, R<sub>g</sub>. This should result in the set functioning in the normal manner.

With reference to the subject of the introduction of a switch to cut both high-frequency valves out of circuit we strongly advise our correspondent not to attempt this, as difficulty is usually experienced before a set with two high-frequency amplifiers is made to work satisfactorily, and once a good arrangement of layout and wiring is obtained it should be adhered to. The incorporation of complicated switching would probably completely upset the balance of the receiver, and is, therefore best omitted. The two H.F. valves can quite easily be cut out of circuit by removing the first two valves and the two H.F. transformers, and by plugging, by means of a flex lead, from the grid socket of the first valve to the socket of the second H.F. transformer which is connected to one side of the detector grid condenser.

S. D. (CAMBERWELL) employs a detector valve followed by two resistance capacity coupled amplifiers, and complains that although he gets London at excellent strength, he is never able to obtain the more distant stations, although he feels a set of this type should be capable of giving

him telephone reception from other stations than London. He submits a diagram of his aerial system.

We are by no means surprised at our correspondent's lack of results on the more distant stations, for although the aerial is 40 ft. above the ground the diagram shows it to be suspended between two chimneys at a distance of only 5 ft. above the roof. The lead-in is also brought down close to the roof and very close to a wall before entering the window of the room in which the set is worked.

From the letter it would appear that suitable precautions have been taken in insulating the aerial at the various points where it goes over the roof and is led in, but we would state that insulation is not the only consideration our correspondent should study, but that "isolation" is equally important. Where an aerial is very close to the roof of a building certain unwanted losses are bound to be introduced, and we think a much better arrangement would be to take the aerial from one chimney to a pole situated at the end of the garden. By this means isolation would be considerably improved, and losses due to absorption reduced to a certain extent, so that there would be a much better chance of distant stations being heard.

R. J. J. (SWANSEA) asks why a large number of modern valves appear to be mirrored with silver internally.

The silver mirror-like appearance of

a number of modern valves is due to a particular process employed to remove the last traces of gas occluded in the metal electrodes and the glass of valves. The particular process responsible for the mirror-like effect is known as the "Getter" process. Usually metallic magnesium is employed, a small piece of this metal being fixed to the anode of the valve during construction. Valves to be "gettered" are exhausted in the normal manner and are then heated, either by the eddy-current method or by lighting the filament and applying a high potential to the plate and grid, when the magnesium volatilises, combining with the last traces of gas, thus giving very high vacuum, which is essential with certain types of dull-emitter valves.

Our correspondent is further referred to *Wireless Weekly*, Vol. 7, No. 1, for a fuller explanation of the process involved.

Erratum

We regret that a slight error was present in the theoretical circuit shown on page 66 of *Wireless Weekly* for September 30. In this the third contact from the left of the first double filament jack is shown connected to the third contact from the left of the second double filament jack. The former contact should be joined to the second contact of the latter jack and not to the third contact.

**MAKE SURE OF PERMANENTLY GOOD RESULTS**  
when you build your set by soldering all connections with the

**Quality RADIO ELECTRIC SOLDERING OUTFIT.**

Soldering is simplified by this new invention which works from any wireless accumulator without needing any gas, fire, or lamp. The **CARBON** soldering-bit needs no tinning or cleaning.

Always ready, everlasting, neat, and complete. Packed in wooden box with instructions.

PRICE **5/6**

Postage 3d.

Or write for free descriptive leaflet No. 24.

**GOSWELL ENGINEERING CO., LTD.,**  
95 to 98, WHITE LION ST., LONDON, N.1

LIBERAL TRADE TERMS. 'Phone: North 3051.

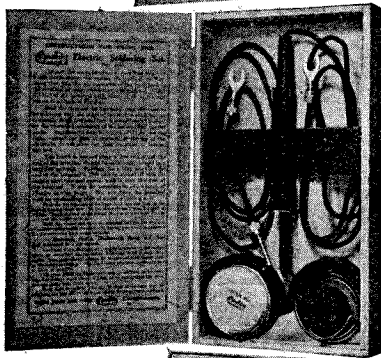

**HAWK COILS**

**MAXIMUM**  
Efficiency  
—  
Strength

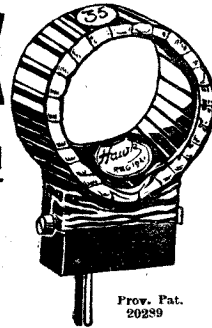

Prov. Pat. 20289

**MINIMUM**  
Capacity  
Damping Effects  
Resistance

Prices below

WATERPROOF

Tel. 832 Kingston.

| Coil | Wave Length using '001 Variable Condenser in Parallel |         | PRICE. |
|------|---|---------|--------|
|      | MAXIMUM   | MINIMUM |        |
| 13   | —   | —       | 2/-    |
| 25   | 395   | 190     | 2/4    |
| 30   | 435   | 240     | 2/4    |
| 35   | 515   | 360     | 2/6    |
| 40   | 680   | 370     | 2/8    |
| 50   | 835   | 485     | 3/-    |
| 75   | 1250  | 600     | 3/4    |
| 100  | 1820  | 815     | 3/10   |
| 150  | 2300  | 960     | 4/8    |
| 200  | 3100  | 1870    | 5/4    |
| 250  | 3750  | 2200    | 5/8    |
| 300  | 4500  | 2300    | 6/-    |
| 400  | 4950  | 2500    | 6/6    |

Sold by all Wireless Dealers

Sole Manufacturers:

**The Hawk Coil Co., LTD.,** ST. MARY'S ROAD, SURBITON, SURREY.



The **ALL-CONCERT  
DE LUXE  
RECEIVER**



**The Set of Super Excellence**

Elegance, ease of control, and efficiency, are all embodied in the "ALL-CONCERT DE LUXE" RECEIVER. It makes the ideal set for the radio enthusiast of fastidious taste, to whom its clean-cut lines give an instant appeal.

The owner of the "ALL-CONCERT" need never be short of a programme. It will give you good Loud-Speaker results from your local station and 5XX. Under favourable conditions, and with an efficient aerial and earth, at least two other stations can be heard at Loud-Speaker strength. All the B.B.C. stations and numerous continental ones are easily heard on the telephones.

Thousands of radio enthusiasts have built the "ALL-CONCERT" to RADIO PRESS

ENVELOPE No. 4 specifications. The Radio Press Envelope system is the safest and simplest way for the novice to build his set.

Percy W. Harris, M.I.R.E., Editor of "The Wireless Constructor" and "Wireless," describes fully and lucidly the various stages in the construction. The beginner's way is also greatly helped by numerous illustrations, including working diagrams, Blue Prints of wiring and panel drilling, and a set of photographic reproductions showing all the details of the receiver.

Obtainable at all Newsagents, Bookstalls, your local Wireless Dealer, or direct from Dept. S., Radio Press, Ltd. For prompt and sure delivery when ordering direct please write your name in BLOCK LETTERS.

**RADIO PRESS LTD.**  
BUSH HOUSE STRAND, W.C.2

**RADIO PRESS  
ENVELOPE No. 4**

PRICE

**2/6**

POST  
FREE

**2/9**

RADIO PRESS  
ENVELOPE  
No. 4

**How to Make  
The "All-Concert de Luxe"  
Receiver**

By PERCY W.  
HARRIS, M.I.R.E.  
Editor of  
"The  
Wireless Constructor."





Marconiphone Publication No. 425 gives full particulars and curves for each type of "Ideal" Transformer. Ask your dealer for a copy.

## The Marconiphone "IDEAL" Transformer and "IDEAL JUNIOR" Transformer

The Marconiphone "Ideal" range of transformers provides a type for every specific purpose. With their use very extensive amplification is possible without distortion. Energy losses are reduced to the minimum, inter-capacity effects between the coils is absolutely minimised, interaction between stages of amplification is impossible and nearby components are not affected. "Ideal" Transformers are rigorously tested at each stage in construction, the highest grade materials are unsparingly used throughout, and the primary windings are impregnated with a special bakelite compound thus ensuring the most perfect internal insulation possible.

Any "Ideal" Transformer will be repaired or replaced free of charge if a break occurs in the windings within six months, subject to reasonable usage.

"IDEAL" TRANSFORMERS are supplied as follows:—  
Type "A," ratio 2.7 to 1; Type "B," ratio 4 to 1; Type "C," ratio 6 to 1; Type "E," ratio 8 to 1.  
Each complete in metal case **35/-**

"IDEAL JUNIOR" TRANSFORMER. This type has been produced in a ratio of 3 to 1, for it was found possible at this ratio only to successfully retain in a simplified form the standard "Ideal" principles of construction.  
Supplied at the popular price of **25/-**

At your radio dealers

Announcement of THE MARCONIPHONE COMPANY, LIMITED, 210-212, Tottenham Court Road, London, W.1